



## T5+ Smart Thermostat

### Programmable Thermostat

RCHT8610WF, RCHT8612WF,  
RTH8800WF

### Product Data



For more information visit [honeywellhome.com](http://honeywellhome.com)

### Included in your box

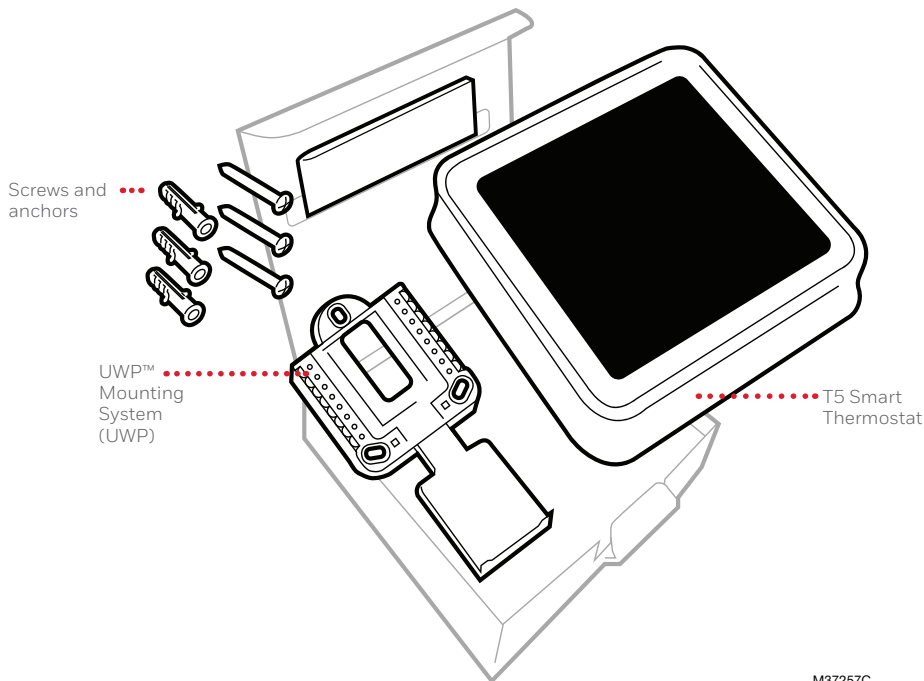

M37257C

## Get the most from T5 Smart Thermostat

Multiple programming options that fit your lifestyle:

-  **1. Location-Based scheduling** – The thermostat uses your smartphone's location to know when you're away, and saves you energy. Through geofence technology, it senses your return and helps make you comfortable upon arrival. You can always manually change your preset Home and Away temperature either on the thermostat or on the Resideo app.
- 2. Smart scheduling** – Use a combination of geofencing and time scheduling to fit your busy, active lifestyle.
- 3. Time-Based scheduling** – Program your thermostat for one week; each day (each day is a different schedule); Mon-Fri, Sat, Sun; or Mon-Fri, Sat-Sun. All days with four adjustable periods per day.
- 4. No scheduling** – Control your comfort manually by adjusting temperature set points only.

 **Smart Alerts.** Push notifications remind you of filter changes and warn you of extreme indoor temperatures.

 **Smart Response.** Learns your heating and cooling system to deliver the optimal temperature at the right time.

 **Auto Change From Heat to Cool.** Automatically determine if your home needs heating or cooling to provide maximum comfort.

# Read and save these instructions.

## Tools you will need

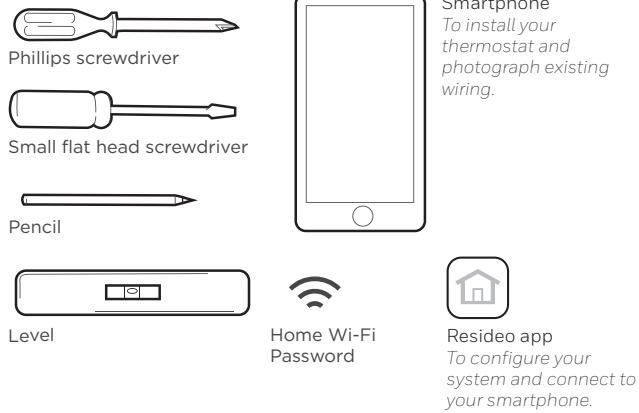

## You may need

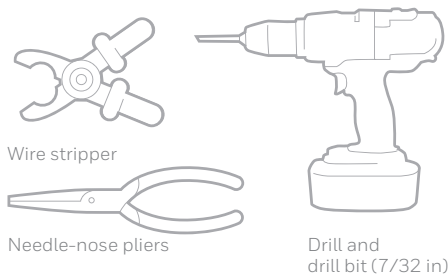

- CAUTION: ELECTRICAL HAZARD**  
Can cause electrical shock or equipment damage. Disconnect power before beginning installation.
- CAUTION: EQUIPMENT DAMAGE HAZARD**  
Compressor protection is bypassed during testing. To prevent equipment damage, avoid cycling the compressor quickly.
- CAUTION: MERCURY NOTICE**  
If this product is replacing a control that contains mercury in a sealed tube, do not place the old control in the trash. Contact your local waste management authority for instructions regarding recycling and proper disposal.
- REQUIRED: 24 VAC POWER ("C" WIRE)**  
C-Wire Power Adapter available to provide power if needed.

## Compatibility

- Compatible with most heating, cooling, and heat pump systems.
- Required: 24 VAC power ("C" wire). C-Wire Power Adapter (THP9045A) can be used if Y and G are used but no C wire is available.
- Does not work with electric baseboard heat (120-240V).
- Does not work with millivolt systems.
- Does not support input (S terminals) for indoor and outdoor sensors.
- Does not support relay (U terminals) for ventilation.
- Android or iOS smartphone, tablet, or device.

## For help, contact

WEB [honeywellhome.com/support](http://honeywellhome.com/support)  
 PHONE 1-800-633-3991  
 SOCIAL Twitter: @Honeywell\_Home, Facebook: Honeywell Home

## Removing your old thermostat

**1 Turn power OFF**  
 To protect yourself and your equipment, Turn off the power at the breaker box or switch that controls your heating/cooling system.

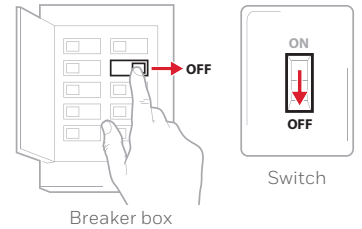

**2 Check that your system is off**  
 Change the temperature on your old thermostat. If you don't hear the system turn on within 5 minutes, the power is off.

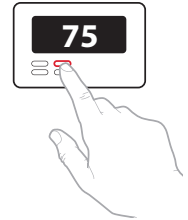

**Note:** If you have a digital thermostat that has a blank display, skip this step.

**3 Remove your old thermostat from the wall plate**  
 On most thermostats, you can take off the thermostat by grasping and gently pulling. Some thermostats may have screws, buttons, or clasps.

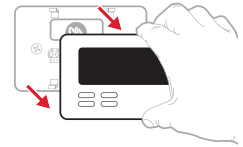

**Do not remove any wires from your thermostat at this time!**

**4 Make sure there are no 120/240V wires**  
 Do you have thick black wires with wire nuts?  
 Is your thermostat 120V or higher?

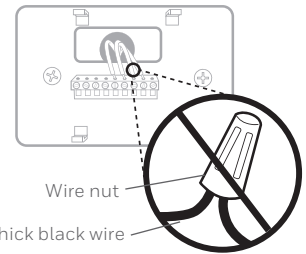

If you answered yes to either of these questions, you have a line voltage system and the thermostat will not work.

If you are unsure visit:  
[honeywellhome.com/support](http://honeywellhome.com/support)

**5 Take a picture of how your wiring looks right now**  
 Be sure to include the letters next to the terminals where the wires are inserted. This will be a helpful reference when wiring your thermostat.



**Tip:** If the color of your wires has faded or if 2 terminals have the same wire color, use the wire labels provided in the package to label each wire.

**6 Remove any jumpers**  
 A jumper connects one terminal to another terminal. It may look like a small staple or even a colored wire and must be removed before continuing. Use a screwdriver to release wires from terminals.

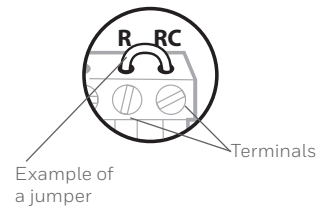

**The thermostat does not need jumpers.**

**7 Record if you have wires in the following terminals**

Do not include jumpers as a part of your count. The thermostat does not need jumpers.

Terminal	Wire Color
<input type="checkbox"/> R	_____
<input type="checkbox"/> RH	_____
<input type="checkbox"/> Rc	_____

**8 Write down the color of the wires**

Check mark the wires that are connected to terminals. Next to the check mark, write down the color of the wire. Do not include jumpers as a part of your count.

Check all that apply (Not all will apply):

Terminal	Wire Color	Terminal	Wire Color
<input type="checkbox"/> Y	_____	<input type="checkbox"/> A or L/A	_____
<input type="checkbox"/> Y2	_____	<input type="checkbox"/> O/B	_____
<input type="checkbox"/> G	_____	<input type="checkbox"/> W2 or AUX	_____
<input type="checkbox"/> C	Required (see step 9)	<input type="checkbox"/> E	_____
		<input type="checkbox"/> W	_____
		<input type="checkbox"/> K	_____

S and U terminals are not supported with this thermostat.

If there are wires in terminals that are not listed, you will need additional wiring support. Visit [honeywellhome.com/support](http://honeywellhome.com/support) to find out if the thermostat will work for you.

**9 Do you see a wire connected to the C terminal?**

If yes, skip to step 10.

If you do not see a C wire, proceed with the options below:

**Option A - Finding the C-Wire:**

There might be an extra wire pushed into the wall or wrapped around the wire bundle. Gently pull the wire bundle out of the wall to check for unused wires.

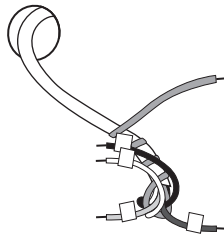

If you have an unused wire, connect that wire to the C terminal on your new thermostat in step 13.

Connect the other end of the unused wire to the C terminal on your heating/cooling system (or the zone panel if your home uses more than one thermostat to control temperature). Be sure any other wire(s) connected to the C terminal stay securely connected when you re-tighten the terminal.

Not all heating/cooling equipment use the C label for the 24 VAC common wire. If your heating/cooling equipment does not have a C terminal, check the system manual or contact the manufacturer to find out which terminal is the 24 VAC common.

Complete installation by following the remaining steps in this guide.

**Option B - Using the C-Wire Power Adapter:**

If you do not have an unused wire in the wall, and Y and G wires are used, the THP9045A C-Wire Power Adapter can be used.

**10 Disconnect the wires and remove the old wall plate**

Use a screwdriver to release wires from terminals.

**Tip:** To prevent wires from falling back into the wall, wrap the wires around a pencil.

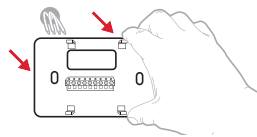

# Installing your T5 Smart Thermostat

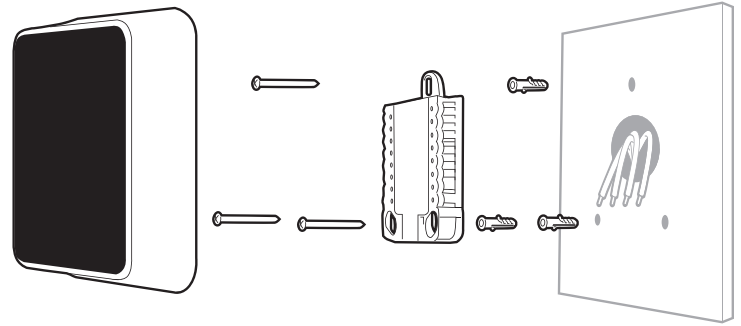

T5 Smart Thermostat    Screws    UWP Mounting System    Anchors    Wall

**11 Bundle and insert wires through the UWP**

Pull open the UWP and insert the bundle of wires through the back of the UWP. Make sure at least 1/4-inch of each wire is exposed for easy insertion into the wire terminals.

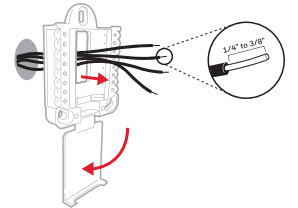

**12 Insert the wall anchors**

It is recommended that you use the wall anchors included in the box to mount your thermostat.

You can use the UWP to mark where you want to place the wall anchors.

- Level the wall plate.
- Mark the location of the wall anchors using a pencil.
- Drill the holes.
- Insert wall anchors.
- Make sure anchors are flush with wall.

**Tip:** Use a 7/32 drill bit.

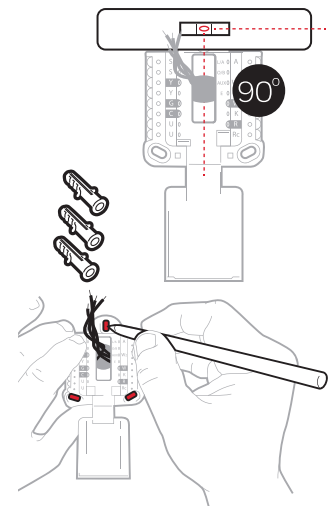

**13 Set R-switch position and insert R-wire or wires**

Set the R-switch up or down based on your wiring notes in **Step 7**.

**!** Insert wires into the inner holes of the terminals on the UWP. The tabs will stay down once the wire is inserted.

**If you have 1 R-wire (R, Rh, or Rc)**

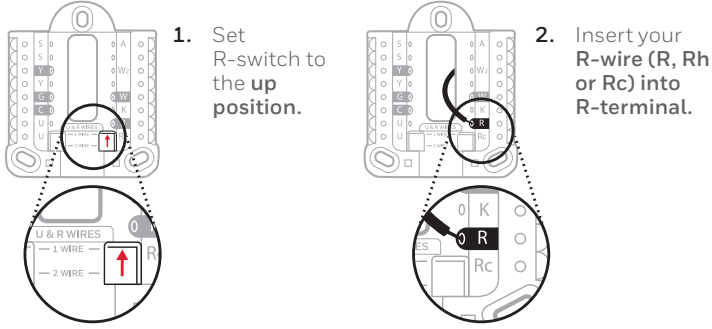

or

**If you have 2 R-wires (R or Rh, and Rc)**

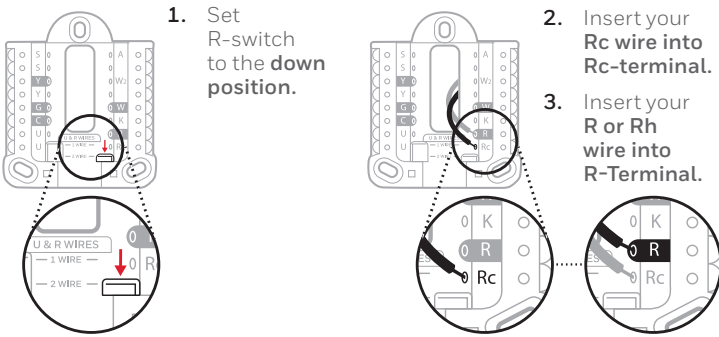

**14 Connect remaining wires from Step 8**

**Tip:** Do not mount the UWP to the wall prior to connecting the wires.

Depress the tabs to put the wires into the inner holes of their corresponding terminals on the UWP (one wire per terminal) until it is firmly in place.

Gently tug on the wires to verify they are secure.

**Tip:** If you need to release the wires again, push down the terminal tabs on the sides of the UWP.

This wiring is just an example, actual wiring may vary.

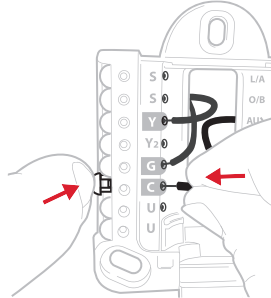

**15 Mount the UWP and close the door**

Mount the UWP using the provided screws. Install all three screws for a secure fit on your wall. Close the door after you're finished.

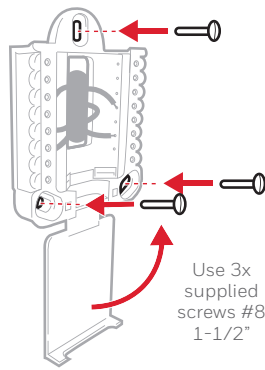

**16 Attach your thermostat**

Align the thermostat onto the UWP and firmly snap it into place.

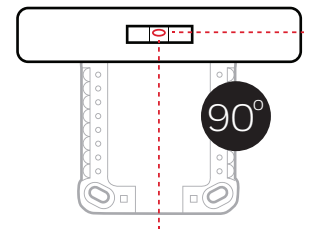

**17 Turn your power ON**

Turn on the power at the breaker box or switch that controls the heating/ cooling system.

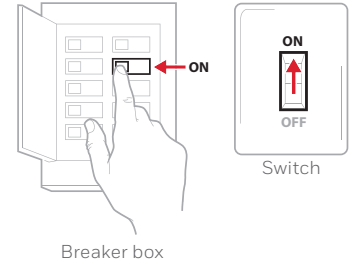

**18 Return to the thermostat**

Return to the thermostat. Confirm the screen shows **START SETUP**. If it does, continue to "Setup with Resideo App" below.

If your thermostat does not show **START SETUP**, please contact Resideo support.



**Setup with Resideo App**

**1 Start Setup with the app**

Touch **START SETUP** on thermostat.



**2 Select to setup with the app**

Touch **Yes** on the **USE APP** screen.

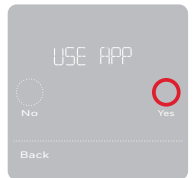

**3 Your thermostat is now ready to be configured using the Resideo app**

- a) Download the "Resideo" app from the App store or Google play.
- b) Open the Resideo app. Your thermostat should appear under Thermostat Found. Tap **SET UP NOW** as shown below to continue. If your thermostat doesn't appear, create an account (if necessary), or sign in to your Resideo account. Then select the T5 Smart Thermostat to install.
- c) The Resideo app will walk you through the rest of setup.

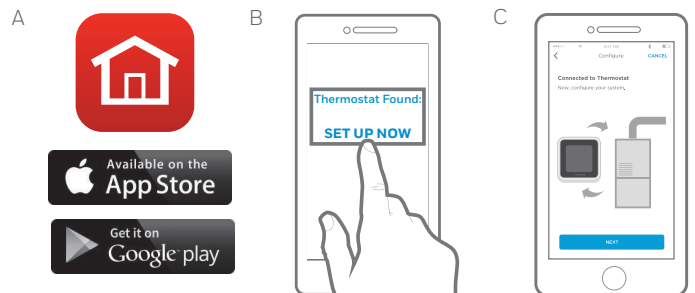

## How to use your Resideo App

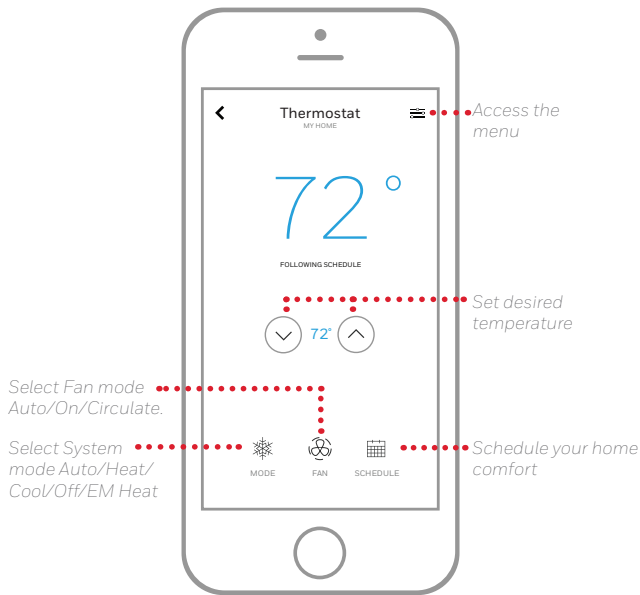

Interested in more Resideo products? Visit [honeywellhome.com](http://honeywellhome.com) to learn about all available products connected by the Resideo app.

App is regularly enhanced and may change.

## How to use your T5 Smart Thermostat

### Desired temperature

Displays desired indoor temperature.

### Indoor Temperature

Displays current indoor temperature.

### Adjust temperature

Touch + or - to set your desired indoor temperature.

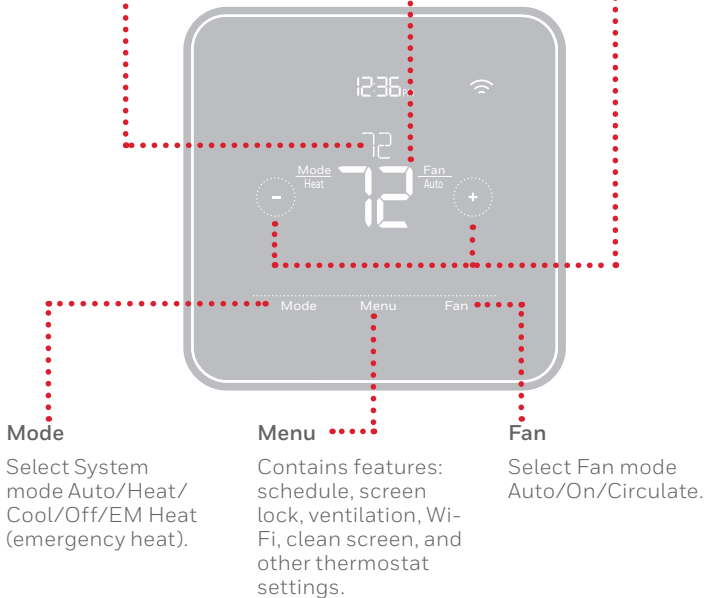

### Mode

Select System mode Auto/Heat/Cool/Off/EM Heat (emergency heat).

### Menu

Contains features: schedule, screen lock, ventilation, Wi-Fi, clean screen, and other thermostat settings.

### Fan

Select Fan mode Auto/On/Circulate.

The screen will wake up by touching the center area of displayed temperature.

## Manual Setup

If your Wi-Fi network is not working, you can alternatively setup your thermostat manually and connect your phone later.

**1 Start manual setup**  
Touch **START SETUP** to begin.

**2 Select manual setup**  
On the **USE APP** screen, touch **No**.

**3 Navigate and edit setup options**  
Use ⏪ or ⏩ to navigate through all the setup options. To see a list of all setup options, go to pages 6-7.

To edit an option value, touch **Edit** or touch text area.

The value is now blinking. Use ⏪ or ⏩ to select the correct value.

Touch **Done** or touch text area once the correct value is selected.

**4 Finish Setup**  
Touch ⏪ until you see **Finish Setup**. Touch **Select** or touch text area.

**5 Setup Wi-Fi**  
At the end of setup process you will be prompted to **SETUP WIFI**. If your Wi-Fi is still not working, you have to manually set the time and date. Select **No** on the **SETUP WIFI** screen.

**6 Set time and date**  
Set daylight saving time if you are in an area that follows daylight saving time. Set date, clock format and time on the next screens.

**7 Your thermostat is now setup**  
Refer to page 5 for more information about basic operation.

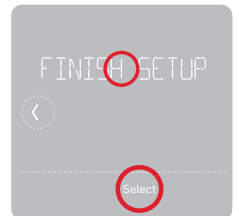
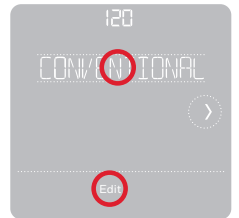
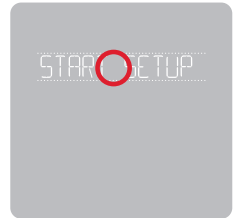

# Equipment Setup Options

**Note:** ISU options available may vary upon the thermostat model and equipment setup.

# ISU	ISU Name	ISU Options (defaults in bold)	Notes
120	Schedule Type	No Schedule MO-SU = Every day the same MO-FR, SA, SU = 5-1-1 schedule <b>MO-FR, SA-SU = 5-2 schedule</b> Each Day = Every day individual	You can change default MO-FR, SA-SU schedule here. To edit periods during days, temperature setpoints, or to turn Schedule On/Off, from the home screen, go to <b>MENU/SCHEDULE</b> .
125	Temp Scale	<b>Fahrenheit</b> , Celsius	
130	Outdoor Temp	<b>No</b> , Internet	Select outdoor temperature data source. This ISU automatically defaults to Internet when registered to the Resideo app. An outdoor temperature is required to set the following ISUs: ISU 355 Compressor Lockout, ISU 356 Aux Heat Lockout.
200	System Type	<b>Conventional Forced Air</b> Heat Pump Boiler Cool Only	Basic selection of system your thermostat will control.
205	Equipment Type	<i>Conventional Forced Air Heat:</i> <b>Standard Gas (STD GAS), High Efficiency Gas (EFF GAS)</b> , Oil, Electric, Fan Coil*  <i>Heat Pump:</i> Air To Air, Geothermal  <i>Boiler:</i> <b>Hot Water</b> , Steam	This option selects the equipment type your thermostat will control. Note: This option is <b>NOT</b> displayed if ISU 200 is set to Cool Only. * Fan coil setting is for a residential application with a hot water coil in an air-handler.
218	Reversing Valve	<b>O/B on Cool</b> , O/B on Heat	This ISU is only displayed if ISU 200 is set to Heat Pump. Select whether reversing valve O/B should energize on cool or on heat
220	Cool Stages (#200=Conv./200=HP)	<b>0, 1, 2</b>	
221	Heat Stages/Aux/E Stages (#200=Conv./200=HP)	Heat Stages: <b>0, 1, 2</b> AUX/E Stages: <b>0, 1</b>	Maximum of 2 Heat Stages for conventional systems. Maximum of 1 Aux/E stages for heat pump systems.
230	Fan Control	Equipment, <b>Thermostat</b>	This ISU is only displayed if ISU 205 is set to Electric Forced Air or Fan Coil.
300	Auto Changeover	On, <b>Off</b>	<b>OFF:</b> The user must select heating or cooling as needed to maintain the desired indoor temperature. <b>ON (Automatic):</b> On (enabled) Allows user to select Auto Changeover as one of the system modes from the home screen. In auto mode, the thermostat can control either heating or cooling to maintain the desired indoor temperature.
303	Auto Differential	<b>0 °F</b> to 5 °F or <b>0.0 °C</b> to 2.5 °C	Differential is the minimum number of degrees rise or fall required during off cycle to switch from the last active mode (heat or cool) to the opposite mode when the thermostat is in auto-changeover. Differential is NOT deadband. The deadband temperature between when heating (or cooling) cycles on and cycles off to maintain setpoint is not adjustable. The T5 thermostat uses an algorithm that fixes deadband at 0 °F.
355	Balance Point (Compressor Lockout)	<b>Off</b> , 5 °F to 60 °F (in 5 °F increments) or -15.0 °C to 15.5 °C (in 2.5 °C or 3.0 °C increments)	Compressor Lockout requires an outdoor temperature. Set Compressor Lockout to the temperature below which it is inefficient to run the heat pump. When outside temperature is below this setting, thermostat will lockout heat pump and run Aux Heat only. This ISU is only displayed if ISU 130 = Internet, ISU 200 is set to Heat Pump, ISU 221 Aux/E stages = 1,.
356	Aux Heat Lock Out (Aux Heat Outdoor Lockout)	<b>Off</b> , 5 °F to 65 °F (in 5 °F increments) or -15.0 °C to 18.5 °C (in 2.5 °C or 3.0 °C increments)	Aux Heat Lockout requires an outdoor temperature. Set Aux Heat Lockout to optimize energy bills and to not allow it to run the more expensive Aux Heat source above certain outdoor temperature limit. This ISU is only displayed if ISU 200 is set to Heat Pump, AND if ISU 221 Aux/E stages = 1.
365	Cool 1 CPH (Cooling cycle rate stage 1)	1 - 6 CPH ( <b>3 CPH</b> )	This ISU is only displayed when Cool /Compressor Stages is set to 1 or more stages. Cycle rate limits the maximum number of times the system can cycle in a 1 hour period measured at a 50% load. For example, when set to 3 CPH, at a 50% load, the most the system will cycle is 3 times per hour (10 minutes on, 10 minutes off). The system cycles less often when load conditions are less than or greater than a 50% load.
366	Cool 2 CPH (Cooling cycle rate stage 2)	1 - 6 CPH ( <b>3 CPH</b> )	This ISU is only displayed when Cool /Compressor Stages is set to 2.

# ISU	ISU Name	ISU Options (defaults in bold)	Notes
370	Heat 1 CPH (Heating cycle rate stage 1)	1 - 12 CPH	This ISU is only displayed when Heat Stages is set to 1 stage or more stages. Cycle rate limits the maximum number of times the system can cycle in a 1 hour period measured at a 50% load. For example, when set to 3 CPH, at a 50% load, the most the system will cycle is 3 times per hour (10 minutes on, 10 minutes off). The system cycles less often when load conditions are less than or greater than a 50% load. The recommended (default) cycle rate settings are below for each heating equipment type: <b>Standard Efficiency Gas Forced Air = 5 CPH; High Efficiency Gas Forced Air = 3 CPH; Oil Forced Air = 5 CPH; Electric Forced Air = 9 CPH; Fan Coil = 3 CPH; Hot Water Radiant Heat = 3 CPH; Steam = 1 CPH.</b>
371	Heat 2 CPH (Heating cycle rate stage 2)	1 - 12 CPH	This ISU is only displayed when Heat Stages is set to 2 stages. The recommended (default) cycle rate settings are below for each heating equipment type: <b>Standard Efficiency Gas Forced Air = 5 CPH; High Efficiency Gas Forced Air = 3 CPH; Oil Forced Air = 5 CPH; Electric Forced Air = 9 CPH; Fan Coil = 3 CPH; Hot Water Radiant Heat = 3 CPH; Steam = 1 CPH.</b>
375	Aux Heat CPH (Heating cycle rate Auxiliary Heat)	1 - 12 CPH	This ISU is only displayed when ISU 200 = Heat Pump and ISU 221=1. It is only displayed when Auxiliary Heat is configured. The recommended cycle rate settings are below for each heating equipment type: <b>Standard Efficiency Gas Forced Air = 5 CPH; High Efficiency Gas Forced Air = 3 CPH; Oil Forced Air = 5 CPH; Electric Forced Air = 9 CPH.</b>
425	Smart Response	<b>On</b> , Off	Smart Response is a comfort setting. Heating or cooling equipment will turn on earlier, ensuring the indoor temperature will match the setpoint at the scheduled time.
429	Max Cool Temperature	from Min. Cool Temp. to 99 °F or to 37.0 °C ( <b>90 °F or 32 °C</b> )	The user cannot set the cooling temperature above this level.
430	Min Cool Temperature	from 50 °F or 10.0 °C to Max. Cool Temp. ( <b>50 °F or 10 °C</b> )	The user cannot set the cooling temperature below this level.
431	Max Heat Temperature	from Min. Heat Temp. to 90 °F or to 32.0 °C ( <b>90 °F or 32 °C</b> )	The user cannot set the heating temperature above this level.
432	Min Heat Temperature	from 40 °F or 4.4 °C to Max. Heat Temp. ( <b>50 °F or 10 °C</b> )	The user cannot set the heating temperature below this level.
702	Air Filters	<b>0</b> - 2	This ISU refers to the number of air filters in the system.
711	Air Filter 1 Reminder	<b>Off</b> 10, 20, 30, 45, 60, 90, 120, 150 Run Time Days 30, 45, 60, 75 Days 3, 4, 5, 6, 9, 12, 15 Months	Choose either calendar or equipment run time-based reminder.
712	Air Filter 2 Reminder	<b>Off</b> 10, 20, 30, 45, 60, 90, 120, 150 Run Time Days 30, 45, 60, 75 Days 3, 4, 5, 6, 9, 12, 15 Months	Choose either calendar or equipment run time-based reminder.
810	Hum Pad Reminder	<b>Off</b> 6, 12 Calendar Months	
921	Dehum Filter Reminder	<b>Off</b> 30, 60 Calendar Days 3 - 12 Calendar Months (in 1 month increments)	
1018	Vent Filter Reminder	<b>Off</b> , 3, 6, 9, 12 months	
1100	UV Devices	<b>0</b> - 2	Some systems may have two UV devices, one for the A-Coil and another for Air Treatment. A replacement reminder can be setup for each one separately.
1105	UV Bulb 1 Reminder	<b>Off</b> , 6, 12, 24 months	
1106	UV Bulb 2 Reminder	<b>Off</b> , 6, 12, 24 months	
1401	Idle Brightness	<b>1-5</b>	Adjust brightness of an inactive backlight (idle screen) from default 1 to 5
1410	Clock Format	<b>12 hour</b> , 24 hour	
1415	Daylight Saving	<b>On</b> , Off	Set to Off in areas that do not follow Daylight Saving Time.



# Frequently Asked Questions

## Will the T5 Smart Thermostat still work if Wi-Fi connection is lost?

Yes, the temperature can be adjusted directly at the thermostat. However, some features, including geofencing, are managed only through the Resideo app and will not function while the connection is down. The thermostat will automatically reconnect to Wi-Fi once the network is restored.

## The T5 Smart Thermostat is not finding the in home Wi-Fi network.

The thermostat operates in the 2.4GHz range. That may be why the thermostat does not see the network but the smartphone, which operates in both the 2.4 and 5.0 GHz range, sees the network. Most routers will broadcast two networks, one SSID on the 5.0 GHz radio and one SSID on the 2.4 GHz radio.

## A change was made on the Resideo app but it has not shown up on the T5 Smart Thermostat.

There may be a short delay after making temperature and setting changes in the Resideo app.

## Can there be multiple users for geofencing?

Yes, there can be multiple users. Geofencing will trigger based on the last person to leave and the first person to return. To properly use geofencing with multiple users:

- Each user needs to create their own account.
- Each user should use their login ID and password across his or her devices, including smartphones and tablets.
- No two users should share the same account.

## How are multiple users set up with thermostat?

Access can be given to any or all thermostat locations through the Resideo app. Start by touching the three-line menu icon in the upper left-hand corner of the home screen. Select Manage Users and touch Add User located at the bottom of the screen. Type in the email address of the person to be invited. If they have an account set up, the location will be automatically added to their account. If they don't have an account, they will receive an email invitation prompting them to download the Resideo app and create their own account.

Note: All individuals with access to a thermostat share the same user privileges. Users added will be able to change the thermostat's settings, as well as add or delete other users.

## Is there a way to extend the signal strength?

The range or distance of the Wi-Fi signal is determined by the router. Check the router's manual for additional information.

## There is an alert that says Wi-Fi Signal Lost. What does that mean?

The Wi-Fi signal to the thermostat has been lost. Wait for the thermostat to reconnect or select a new network within the Resideo app configuration menu. If the thermostat is unable to reconnect, you will need to troubleshoot the router to determine the cause.

## Why is the thermostat showing up as offline (strike-through Wi-Fi icon) on top of right corner of thermostat display?

If the thermostat displays a strike-through Wi-Fi icon on its screen or shows up as offline on the Resideo app, it has lost connection to the network. Make sure the router is powered and broadcasting. The home's Wi-Fi network may need to be reset by power cycling the router. Consult the router's instruction manual for directions on power cycling. When the network has been restored, the thermostat will automatically reconnect.

## An activation email hasn't been received.

An email will be sent from connected-Home@alarmnet.com. An activation email is needed to complete the account setup. If an activation email is not received after five minutes, check the Spam folder of the email account.

If you do not find it in the Spam folder, click on the Resend button and the activation email will be resent. If you still do not receive your activation email, please contact the Technical Support team at 1-800-633-3991 for help.

# Regulatory information

## FCC REGULATIONS

### 47 CFR § 15.19 (a)(3)

This device complies with part 15 of the FCC Rules. Operation is subject to the following two conditions:

1. This device may not cause harmful interference, and
2. This device must accept any interference received, including interference that may cause undesired operation.

### 47 CFR § 15.21 (USA only)

Changes or modifications not expressly approved by the party responsible for compliance could void the user's authority to operate the equipment.

## 47 CFR § 15.105 (b)

See <https://customer.resideo.com/en-US/support/residential/codes-and-standards/FCC15105/Pages/default.aspx> for additional FCC information for this product.

## IC REGULATIONS

### RSS-GEN

This device contains licence-exempt transmitter(s)/receiver(s) that comply with Innovation, Science and Economic Development Canada's licence-exempt RSS(s). Operation is subject to the following two conditions:

1. This device may not cause interference.
2. This device must accept any interference, including interference that may cause undesired operation of the device.



## Apple® HomeKit™ Setup Code

The T5+ Smart Thermostat supports Apple HomeKit. Open HomeKit app, follow the instructions, and enter the code displayed on Thermostat when prompted.

## 2-Year Limited Warranty

For Warranty information go to [honeywellhome.com](http://honeywellhome.com)

 **CAUTION: ELECTRICAL HAZARD**  
Can cause electrical shock or equipment damage. Disconnect power before beginning installation.

 **CAUTION: EQUIPMENT DAMAGE HAZARD**  
Compressor protection is bypassed during testing. To prevent equipment damage, avoid cycling the compressor quickly.

 **CAUTION: MERCURY NOTICE**  
If this product is replacing a control that contains mercury in a sealed tube, do not place the old control in the trash. Contact your local waste management authority for instructions regarding recycling and proper disposal.

 **CAUTION: ELECTRONIC WASTE NOTICE**  
The product should not be disposed of with other household waste. Check for the nearest authorized collection centers or authorized recyclers. The correct disposal of end-of-life equipment will help prevent potential negative consequences for the environment and human health.

Use of the Works with Apple badge means that an accessory has been designed to work specifically with the technology identified in the badge and has been certified by the developer to meet Apple performance standards. Apple is not responsible for the operation of this device or its compliance with safety and regulatory standards.

AirPlay, iPad, iPad Air, iPad Pro, iPhone and iPod touch are trademarks of Apple Inc., registered in the U.S. and other countries. HomePod is a trademark of Apple Inc.







**resideo**

[www.resideo.com](http://www.resideo.com)

Resideo Inc., 1985 Douglas Drive North  
Golden Valley, MN 55422

33-00474-04 SA Rev.11-23

Wi-Fi® is a registered trademark of  
Wi-Fi Alliance®



33-00474-04