



C-WIRE ADAPTER

Installation Guide

Online Guides and Support

resideo.com

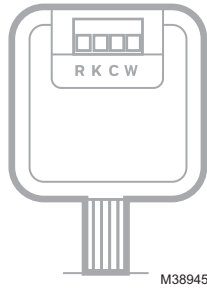

M38945



33-00618-03

Overview

This product provides a C wire (common wire) to power a thermostat. Only install if you do not have a C wire available to connect to your thermostat.



ZONING CONTROL PANEL CHECK

For zoned systems, install the C Wire Adapter between the thermostat and the zoning panel, NOT between the zoning panel and HVAC equipment.

BEFORE

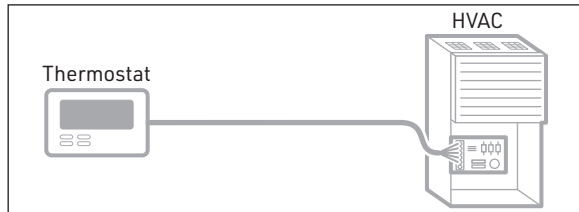

M38946

AFTER

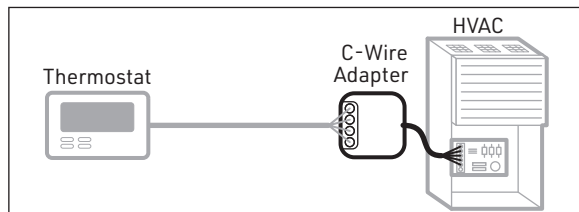

M38947

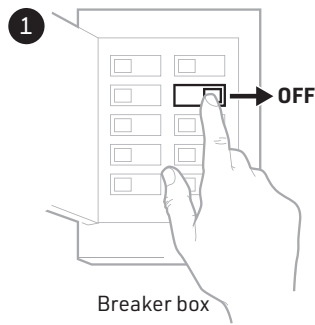

Breaker box

Turn the power off at the breaker box or control switch for your HVAC* system.



Switch

*Heating, ventilation, and air conditioning
M38948

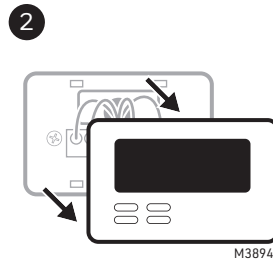

M38949

Remove your old thermostat from the wall plate.

Do not remove any wires at this time!

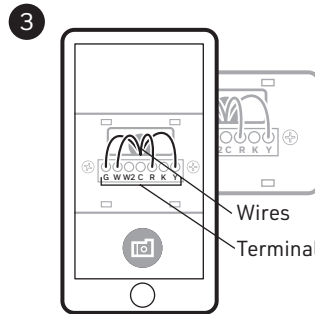

Wires
Terminal Labels

Take a picture of the wiring.

Ensure the terminal labels and wires are in the image.

You may need to reference the picture later.

M38950

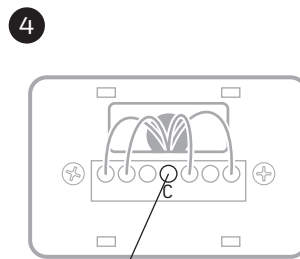

C terminal *

M38951

Confirm that you do not have a wire in the C terminal. If you have a wire in the C terminal, then you do not need this product.

Look for an unused wire. If you have an unused wire, then you do not need this product. Connect one end of that wire to C terminal at the HVAC and the other to C terminal at new thermostat.

* The C wire (common) might be labeled as B rather than C on certain thermostats.

Go to your HVAC system. It may be located in your attic, crawl space or basement.

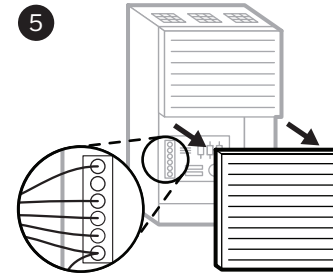

Open HVAC system's cover to reveal the control board.

M38952

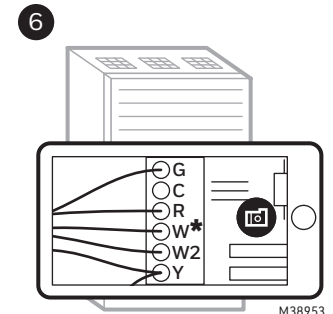

M38953

Take a picture of the wires on the control board.

Ensure the terminal labels and wires are in the image.

You may need to reference the picture later.

* O or B terminal may also be used.

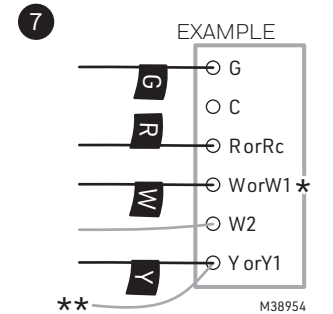

EXAMPLE

Use stickers to label the following connected wires:

- G
- R or Rc
- W or W1
- Y or Y1

* Not all systems will have a W or W1-wire. On a heat pump application, the wire coming from O/B on the old thermostat would match to either O or B at equipment rather than W.

** If multiple wires are connected to a terminal, only label the the wire running to your thermostat.

M38954

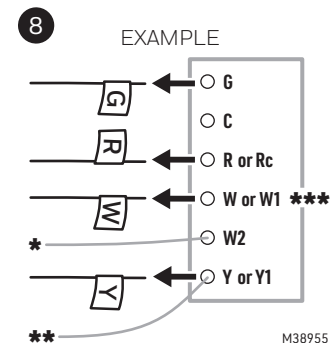

EXAMPLE

Disconnect ONLY the wires that you just labelled:

- G
- R or Rc
- W or W1
- Y or Y1

* Do NOT disconnect wires that you did not label.

** If multiple wires are connected to a terminal, only remove the the wire running to your thermostat.

*** On a heat pump application, the wire coming from O/B on the old thermostat would match to either O or B at equipment rather than W.

M38955

9 Insert the wires you just disconnected into the C-Wire Adapter terminals.

Wires	Terminals
W or O/B	W or O/B
G	C
Y	K
R	R

This will convert the G and Y-wires into C and K-wires.

10 Take a picture of the wires you inserted into the C-Wire Adapter.

Ensure the terminal labels and wires are in the image.

You may need to reference the picture later.

11 Connect the wires from the "Equipment" labelled side of the C-Wire Adapter to the matching terminals on the control board.

EXAMPLE

- G
- C
- R
- W, W1, O, or B*
- W2
- Y or Y1

* If there are separate wires to W and O, leave the W and O wires attached at HVAC and do not connect them to the C-Wire Adapter.

12 CHECKPOINT

Your C-Wire Adapter should now be installed between your thermostat wiring and the control board.

13 Before mounting, check to make sure surface is clean enough to ensure good adhesion.

Attach the C-Wire Adapter to the inside wall of the furnace using the magnet on the back of the C-Wire Adapter.

Note: Earlier versions of this product had an adhesive pad and mount rather than magnet.

14 Close the HVAC system's cover.

⚠ Leave the power off.

Go back to your thermostat.

15 Label your now converted wires as shown.

Wires	Labels
G	C
Y	K

The wires you label C and K are the wires you inserted into the C and K-terminals in step 9.

16 Label ALL of the remaining wires according to their terminals.

* O/B terminal may also be used.

17 **Confirm you have labelled ALL of your wiring.**

Disconnect the wires from the old wall plate.

* O/B terminal may also be used.

18 NEXT STEPS

Refer to your new thermostat's installation guide for detailed instructions to complete the following tasks below.

A Remove the old wall plate and mount the new one.

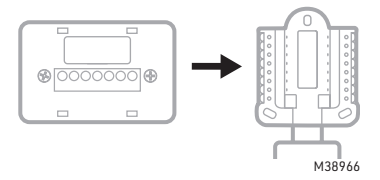

B Wire the new thermostat.

⚠ Refer to the labels you applied when inserting the wires.

When done wiring, you should have wires in the C and K-terminals.

You should not have wires in the Y or G-terminals.

C Complete your new thermostat's installation by attaching the thermostat to the wall plate, restoring the power, and configuring the thermostat.