

SUPER TRADELINE

AT72D TRANSFORMERS

APPLICATION

The AT72D is a multimounting, stepdown transformer for use in 24 Vac control systems. It is listed by Underwriters Laboratories Inc. and Canadian Standards Association, and meets NEC Class 2 not wet, Class 3 wet requirements. It also complies with 24 V NEMA Type D requirements as specified by NEMA Standard ST2-1979. One of these transformers will directly replace one of the Honeywell AT72D,E transformers with 120, 208, or 240

Vac primaries, except those with 32 in. (813 mm) leads and 1/2 in. conduit hub on secondary.

The AT72D SUPER TRADELINE Transformer will also replace Honeywell AT12D and AT20D plate-mounted transformers. AT72D mounting options include foot mounting; plate mounting (transformer all above plate, or 3/4 above plate) for use on 4 x 4 in., 4 in. octagon, and 2 x 4 in. electrical boxes; and clamp mounting via a junction box knockout.

TABLE 1—MODEL INFORMATION

MODEL	PRIMARY		SECONDARY		OUTPUT AT 100 PERCENT POWER RATING	OVERLOAD PROTECTION
	VOLTAGE AND FREQUENCY	WIRING CONNECTIONS	VOLTAGE	WIRING CONNECTIONS		
AT72D	120 V, 50/60 Hz	Two 9 in. [228.5 mm] Leadwires	24 Vac	2 Screw Terminals	40 VA	Energy Limited
	208/240 V, 50/60 Hz	Three 9 in. [228.5 mm] Leadwires	24 Vac	2 Screw Terminals	40 VA	Energy Limited

INSTALLATION

WHEN INSTALLING THIS PRODUCT . . .

1. Read these instructions carefully. Failure to follow them could damage the product or cause a hazardous condition.
2. Check the ratings given in the instructions and on the product to make sure the product is suitable for your application.
3. Installer must be a trained, experienced service technician.
4. After installation is complete, check out product operation as provided in these instructions.

CAUTION

Disconnect power supply before beginning installation to prevent electrical shock or equipment damage.

MOUNTING

Mount the transformer to meet the application. Use one of the methods illustrated. Transformer can be mounted in any position.

FOOT MOUNTING (Fig. 1)

1. Discard mounting plate.
2. Use screws or bolts through slots in mounting feet to fasten transformer to mounting surface.

PLATE MOUNTING (Figs. 2-6)

To plate mount transformer:

1. Mount plate to transformer.
2. Mount transformer and plate to electrical box.

Mounting Plate to Transformer

The plate may be mounted to transformer in one of two positions: (1) at clamp on primary end bell (transformer all above plate), or (2) at the laminations (transformer 3/4 above plate). See Fig. 2.

This is a legacy product document supported by Resideo. It is no longer manufactured

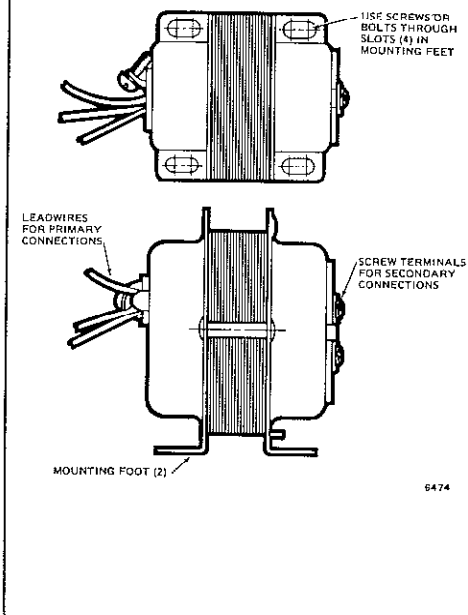

Fig. 1—Foot mounting.

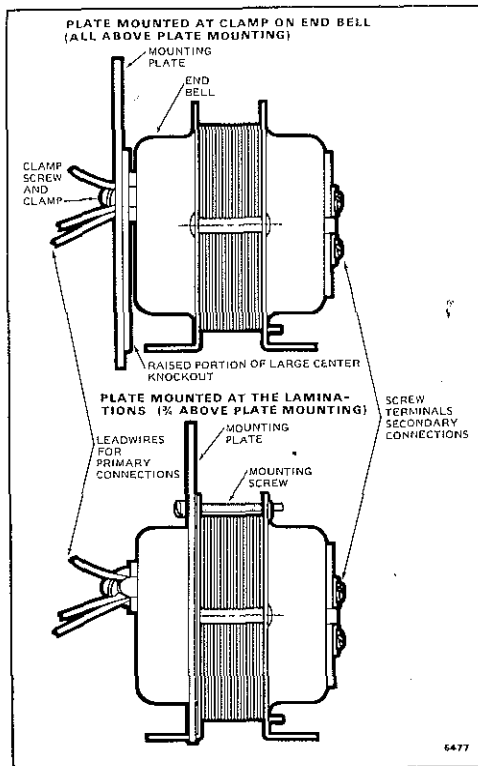

Fig. 2—Plate may be mounted to transformer in one of two positions.

To mount plate at clamp on primary end bell (all above plate mounting):

1. Take mounting plate in one hand. Keep the keyhole slots up and the raised portion of the large center knockout toward you.
2. Insert the primary leadwires through the center hole in plate.

3. Fit hole in plate over clamp attached to the end bell. Clamp screw must be turned almost completely out.

4. With plate in place over clamp, tighten screw securely against rim of round hole. See Fig. 3. Avoid damaging the leadwires with the screwdriver.

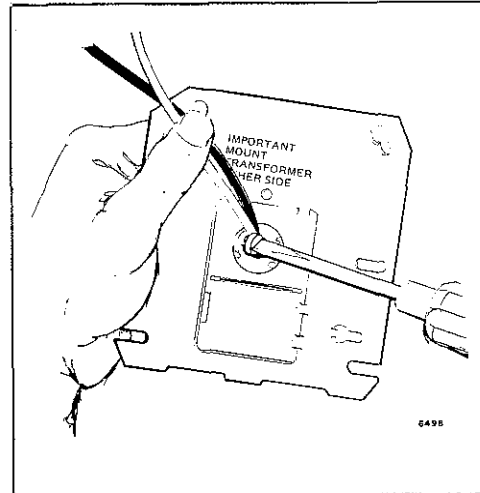

Fig. 3—Tighten clamp securely against rim of round hole.

To mount plate at the laminations (3/4 above plate mounting):

1. Remove large center knockout in mounting plate as illustrated in Fig. 4.
2. Take transformer in one hand. Clamp on end bell should face you.
3. Take the mounting plate in the other hand. Keyhole slots should be up.
4. Place large knockout in mounting plate over primary leadwires and end bell. Small tab at bottom center of plate fits into slot in transformer mounting foot.
5. Insert mounting screw through holes as illustrated in Fig. 5. Secure plate to transformer. Do not overtighten screw.

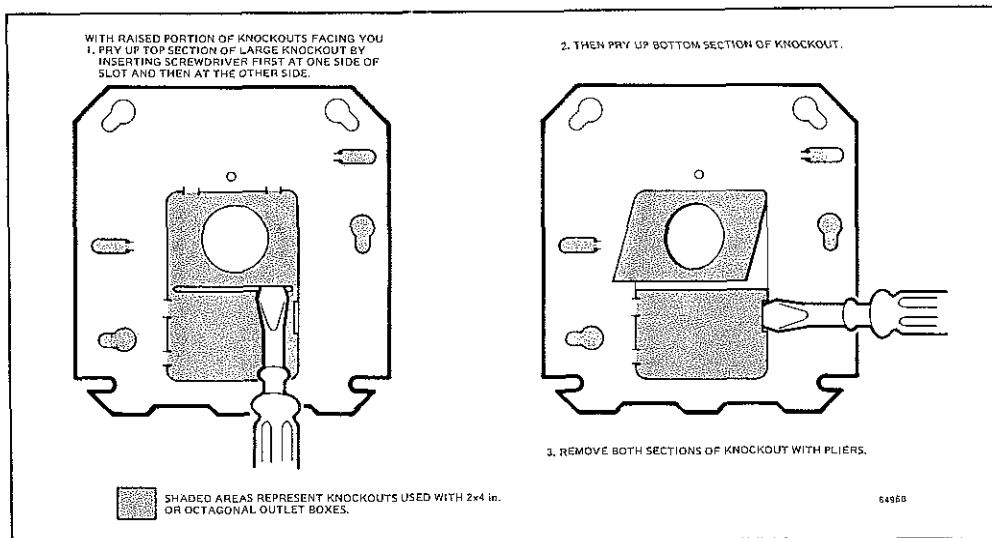

Fig. 4—Removing large center knockout.

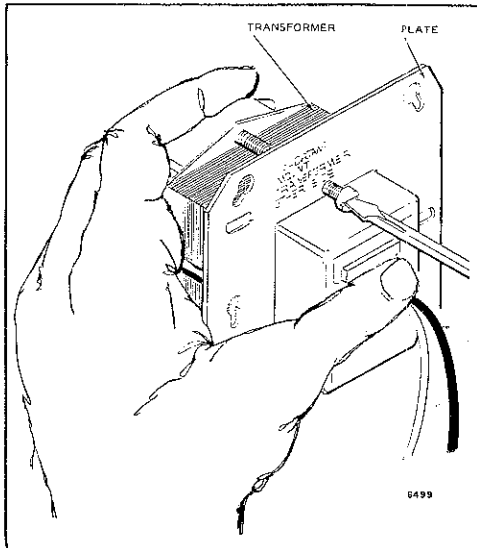

Fig. 5—Secure plate to transformer with mounting screw.

Mounting Transformer and Plate to Electrical Box

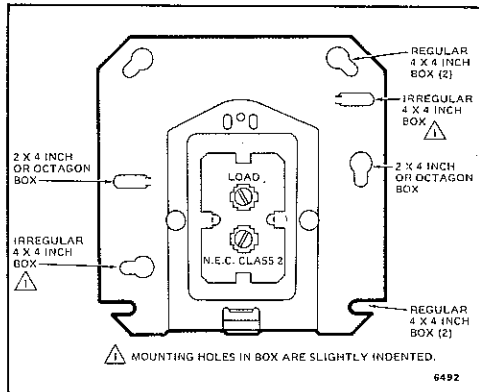

Fig. 6—Location of mounting holes in plate.

The mounting plate may be mounted to 4 x 4 in. boxes with regular and irregular spaced mounting holes, to 2 x 4 in. boxes, and to 4 in. octagon boxes. See Fig. 6. Use the screws supplied with the electrical box. Place them through the proper mounting holes in the plate and

secure transformer and plate to box. Punch out appropriate knockouts for plate mounting holes, if necessary.

NOTE: Transformer feet should always be outside of junction box.

CLAMP MOUNTING VIA JUNCTION BOX KNOCKOUT

The transformer may also be clamp mounted via a junction box knockout, if desired. This mounting option does not require use of mounting plate.

To mount transformer within knockout:

1. Insert primary leadwires, and clamp and screw on transformer end bell through suitable 1/2 in. knockout in junction box. Clamp screw must be turned almost completely out in order to get clamp through knockout.
2. Tighten clamp screw securely against rim of knockout. Avoid damaging the leadwires with the screwdriver.

WIRING

Disconnect power before installing transformer. All wiring must comply with local electrical codes and ordinances. Tape all unused exposed leadwires separately.

1. Connect primary leadwires to line voltage power supply. See Fig. 7.

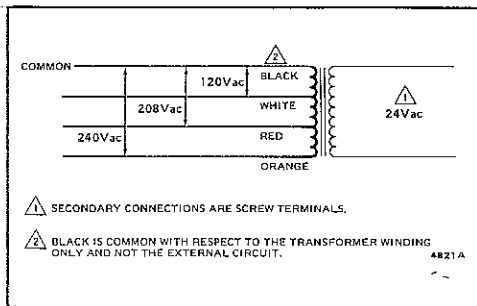

Fig. 7—Transformer schematic.

2. Connect transformer secondary leads to 24 Vac control system.

CHECKOUT

After installation is complete, turn on power supply. Place controlled equipment in operation and observe through at least one complete cycle. Make sure it functions as intended.