



S8600, S8610, S8660, S8670 Intermittent Pilot Module

INSTALLATION INSTRUCTIONS

APPLICATION

These ignition modules provide ignition sequence, flame monitoring, and safety shutoff for intermittent pilot central furnaces and heating appliances. S8600 and S8660 models provide up to 1.0A pilot and 1.0A main valve current rating. S8610 and S8670 models provide up to 1.0A pilot and 2.0A main valve current rating.

Minimum ambient temperature rating is -40° F (-40° C). Maximum ambient rating is 175° F (79° C) for S8600, S8660 and for S8610, S8670 used with 1.0A or less main valve. Maximum ambient rating for S8610, S8670 used with 1.0 to 2.0A main valve is 165° F (74° C). See Table 1 for a summary of other differences between models.

Table 1. Intermittent Pilot Ignition Modules.

Model	Igniter Sensor Type	Type of Gas	Prepurge Timing	100 Percent Shutoff	Lockout Timing	Ignition Sequence ^a
S8600A, S8610A	Separate	Natural	None	No	No	Spark on until pilot lightoff or manual shutoff; pilot valve open until manual shutdown.
S8600F, S8610F	Combination					
S8600B, S8610B	Separate	Natural or LP	None	Yes at lockout	15 or 90 sec. max., as ordered	Spark on until lightoff or lockout; pilot valve closes on lockout.
S8600H, S8610H	Combination	Natural or LP	None	Yes at lockout	15 or 90 sec. max., as ordered	Spark on until lightoff or lockout; pilot valve closes on lockout.
S8600M	Combination	Natural or LP	None	Yes, at 90 sec. max.	No, continuous retry	Spark and pilot gas on until shutoff. After 5-min. minimum (6-min. nominal) delay, ignition starts again. Ignition, wait, retry repeats until pilot lights or system is shutdown manually.
S8660D, S8670D	Combination	Natural or LP	45 sec.	Yes, at 90 sec. max.	15 or 90 sec. max., as ordered	Ignition trial follows prepurge; spark on until lightoff or lockout; pilot valve closes on lockout.

^a If established flame is lost, all models restart ignition trial.

BEFORE INSTALLATION

Intermittent pilot systems are used on a wide variety of central heating equipment and on heating appliances such as commercial cookers, agricultural equipment, industrial heating equipment and pool heaters. Some of these applications may make heavy demands on the controls, either because of frequent cycling, or because of moisture, corrosive chemicals, dust or excessive heat in the environment. In these situations, special steps may be required to prevent nuisance shutdowns and premature control failure. These applications require Resideo Residential Division Engineering review; contact your Resideo Sales representative for assistance.

Frequency Cycling

These controls are designed for use on space heating appliances that typically cycle 3 to 4 times an hour during the heating season and not at all during the cooling season. In an application with significantly greater cycling rates and closer to year-round use, we recommend monthly checkouts because the controls may wear out more quickly.



Water or Steam Cleaning

Once a module or gas control has been wet, it may operate unreliably and must be replaced. If the appliance is likely to be cleaned with water or steam, the controls and associated wiring should be covered so water or steam flow cannot reach them. The controls should be high enough above the bottom of the cabinet so they will not be subject to flooding or splashing during normal cleaning procedures. If necessary, shield the controls to protect them from splashing water. A NEMA 4 enclosure is recommended for the ignition module; see the Electronic Ignition Service Manual, form 70-6604.

High Humidity or Dripping Water

Over time, dripping water or high ambient humidity can create unwanted electrical paths on the module circuit board, causing the module to fail. Never install an appliance where water can drip on the controls.

In addition, high ambient humidity can cause the gas control to corrode, and finally to fail.

Where the appliance may be installed in a humid atmosphere, make sure air circulation around the module and gas control is adequate to prevent condensation. It is also important to regularly check out the system. A NEMA 4 enclosure may be needed; see the Electronic Ignition Service Manual, form 70-6604.

Corrosive Chemicals

Corrosive chemicals can also attack the module and gas control and eventually cause a failure. Where chemicals may be used routinely for cleaning, make sure the cleaning solution cannot reach the controls. Where chemicals are likely to be suspended in air, as in some industrial and agricultural applications, protect the ignition module from exposure with a NEMA 4 enclosure; see the Electronic Ignition Service Manual, form 70-6604.

Dust or Grease Accumulation

Heavy accumulation of dust or grease may cause the controls to malfunction. Where dust or grease may be a problem, provide covers for the module and the gas control that will limit environmental contamination. A NEMA 4 enclosure is recommended for the ignition module; see the Electronic Ignition Service Manual, form 70-6604.

Heat

The controls can be damaged by excessively high temperatures. Make sure the maximum ambient temperature at the control locations will not exceed the rating of the control. If the appliance normally operates at very high temperatures, insulation, shielding, and air circulation may be necessary to protect the controls. Proper insulation or shielding should be provided by the appliance manufacturer; make sure adequate air circulation is maintained when the appliance is installed.

INSTALLATION

When Installing This Ignition System...

1. Read these instructions carefully. Failure to follow them could damage the components or cause a hazardous condition.
2. Check the ratings given in the instructions and on the components to make sure they are suitable for your application.
3. Installer must be a trained, experienced service technician.
4. After installation is complete, check out component operation as provided in these instructions.



WARNING

Fire or Explosion Hazard. Can cause severe injury, death or property damage.

1. The ignition module can malfunction if it gets wet, leading to accumulation of explosive gas.
 - Never install where water can flood, drip, or condense on module.
 - Never try to use a module that has been wet—replace it.
2. Liquefied petroleum (LP) gas is heavier than air and will not vent upward naturally.
 - Do not light pilot or operate electric switches, lights or appliances until you are sure the appliance area is free of gas.



CAUTION

Electrical Shock Hazard. Can cause severe injury, death or property damage.

1. Disconnect power supply before beginning wiring to prevent electrical shock or equipment damage.
2. If a new gas control is to be installed, turn off gas supply before starting installation. Conduct Gas Leak Test according to gas control manufacturer instructions after the gas control is installed.
3. If module must be mounted near moisture or water, provide suitable waterproof enclosure.

Perform Preinstallation Safety Inspection

The preinstallation checks described in ANSI Standard Z21.71 on page 19 must be done before the replacement module is installed. If a condition which could result in unsafe operation is detected, the appliance should be shut off and the owner advised of the unsafe condition. Any potentially unsafe condition must be corrected before proceeding with the installation.

Maintenance Requirements in Severe Environments

Regular preventive maintenance is important in any application, but especially in commercial cooking, agricultural, and industrial applications, because:

1. In many such applications, particularly commercial cooking, the equipment operates 100,000-200,000 cycles per year. Such heavy cycling can wear out the gas control in one to two years. A normal forced air furnace, for which the controls were originally intended, operates less than 20,000 cycles per year.

- Exposure to water, dirt, chemicals, and heat can damage the module or the gas control and shut down the control system. A NEMA 4 enclosure can reduce exposure to environmental contaminants. See Electronic Ignition Service Manual, form 70-6604.

The maintenance program should include regular checkout of the system as outlined under CHECKOUT, page 11.



WARNING

Fire or Explosion Hazard. Can cause severe injury, death or property damage.

Do not attempt to take the module apart or to clean it. Improper reassembly and cleaning may cause unreliable operation.

Maintenance frequency must be determined individually for each application. Some considerations are:

- Cycling frequency.** Appliances that may cycle more than 20,000 times annually should be checked monthly.
- Intermittent use.** Appliances that are used seasonally should be checked before shutdown and again before the next use.
- Consequence of unexpected shutdown.** Where the cost of an unexpected shutdown would be high, the system should be checked more often.
- Dusty, wet, or corrosive environment.** Since these environments can cause the controls to deteriorate more rapidly, the system should be checked more often.

Any control should be replaced if it does not perform properly on checkout or troubleshooting. In addition, replace any module if it is wet or looks like it has ever been wet. Protective enclosures as outlined under "Planning the Installation" are recommended regardless of checkout frequency.

Mount Ignition Module

Select a location close enough to the burner to allow a short 3 ft. (0.9 m) max. direct cable route to the igniter. Ambient temperature at the module must be within the range listed under APPLICATION, page 1. The module must be protected from water, moisture, corrosive chemicals and excessive dust and grease.

We recommend mounting the module with the terminals down to protect them from dripping water and dust. It can also be mounted with the terminals on either side. DO NOT MOUNT with the terminals pointing up. Fasten securely with four No. 6-32 machine or No. 8 sheetmetal screws.

Mount the System Controls

Among any required controls, such as the gas control, spark igniter, flame sensor, thermostat, limit and transformer according to manufacturer's instructions.

Wire the System



CAUTION

Electrical Shock Hazard.

Can cause severe injury, death or property damage.

- Check the wiring diagram furnished by the appliance manufacturer, if available, for circuits differing from the wiring hookups shown in this publication. Carefully follow any special instructions affecting the general procedures outlined below.
- Disconnect the power supply before making wiring connections to prevent electrical shock or equipment damage.

IMPORTANT

- As shown in the wiring diagrams, a common ground is required on:
 - The pilot burner mounting bracket, and the GND (BURNER) terminal on the ignition module.
 - Failure to use the GND (BURNER) terminal may result in intermittent loss of spark and/or loss of flame current sensitivity.
- Make sure the transformer has adequate VA. The ignition module requires at least 0.2A at 24 Vac. Add the current draws of all other devices in the control circuit, including the pilot and main valves in the gas control, and multiply by 24 to determine the total VA requirement of these components. Add this total to 4.8 VA (for the ignition module). The result is the minimum transformer VA rating. Use a Class II transformer if replacement is required.

Connect Ignition Cable

Use Resideo ignition cable or construct an ignition cable that conforms to suitable national standards such as Underwriters Laboratories Inc. (See Tables 2 and 3).

Table 2. Resideo Preassembled Ignition Cables (UL Style 3257).

Cable Part Number	Length	Module End	Igniter End
394800-30	30 in. (762 mm)	1/4 in. quick connect, insulated	Rajah connector receptacle, 90 deg. rubber boot
394801-30	30 in. (762 mm)	1/4 in. quick connect, insulated	Rajah connector receptacle, straight rubber boot

Table 3. Recommended Ignition Cable for Field Assembly.

Cable Type	Voltage Rating (rms)	Temperature Rating	
		C	F
UL Style 3217	10,000	150	302
UL Style 3257	10,000	250	484

Cable must be no longer than 36 in. (0.9 m). To construct a cable, fit one end of ignition cable with 1/4 in. diameter Rajah connector receptacle and the other with a 1/4 in. female quick connect. Protect both ends with insulated boots.

NOTE: The cable must not run in continuous contact with a metal surface or spark voltage will be greatly reduced. Use ceramic or plastic standoff insulators as required.

To Install:

1. Connect one end of the cable to the male quick connect SPARK terminal on the ignition module.
2. Connect the other end of the cable to the igniter or igniter-sensor stud on the pilot burner/igniter-sensor.

Connect Vent Damper

The D80B Vent Damper can be used with all ignition modules, although the Molex plug provided on some modules simplifies wiring connections when used with the D80D Plug-In Vent Damper. Once a module with vent damper plug has powered a vent damper circuit, it cannot be used in a gas system without a vent damper. A non-replaceable fuse in the module blows on initial power-up. Once this fuse has blown, the module will not work unless the vent damper is connected.

To connect the plug-in model to the D80D:

1. Remove the plug from the terminal strip on the ignition module case and discard.
2. Using the wiring harness supplied, insert the matching pin plug into receptacle on case and other end to vent damper.
3. To connect the D80B, follow the wiring diagrams supplied with the vent damper or Refer to Fig. 7 for typical connections.

Connect Ignition Module

1. Connect remaining system components to the ignition module terminals as shown in the appropriate wiring diagram, Figures 1 through 10.
2. Fig. 1 is a basic circuit for a heating only atmospheric burner with S8600F,H,M S8660D or S8670D.
3. Fig. 2 shows S8600F,H,M; S8610F,H with vent damper plug in a heating only atmospheric burner system with D80D vent damper. *Never* use a vent damper in an LP gas system or in a fan-assisted combustion system.
4. Figures 3 and 4 show S8600A,B; S8610A,B with separate sensor and igniter, with and without the D80D vent damper.
5. Figures 5 through 10 show S8600F,H,M; S8610F,H; S8660D; and S8670D in a variety of systems, with alternate connections for modules with vent damper plug. Remember, however, that a vent damper should not be used in an fan-assisted combustion system or an LP gas system and that the vent damper plug must not be removed except to connect the module to a D80D with the plug-in cable. S8600A,B; S8610A,B can be substituted in these drawings by simply connecting the igniter and sensor as shown in Figures 3 and 4.
6. Refer to heating appliance manufacturer's instructions for wiring auxiliary controls.
7. Adjust thermostat heat anticipator to match system current draw. The current draw equals the total current required for the ignition module (0.2A) plus the gas control and any other auxiliary equipment in the control circuit.

Connect Gas Control

Use No. 18 gauge solid or stranded wire. Use 1/4 in. female quick connects for module connections. Connect to gas control terminals as shown in wiring diagrams, using terminals appropriate to the gas control.

Ground Control System

The igniter, flame sensor and ignition module must share a common ground with the main burner. Use thermoplastic insulated wire with a minimum rating of 221° F (105° C) for the ground wire; asbestos insulation is not acceptable. If necessary, use a shield to protect the wire from radiant heat generated by the burner. Connect the ground wire as follows:

1. Fit one end of the ground wire with a female ¼ in. quick-connect terminal and connect it to the male quick-connect GND (BURNER) terminal on the ignition module.
2. Strip the other end of the wire and fasten it under the igniter bracket mounting screw. If necessary, use a shield to protect the ground wire from radiant heat.
3. The burner serves as the common grounding area. If there is not good metal-to-metal contact between the burner and ground, run a lead from the burner to ground.

NOTE: "Earth" ground is not required.

Replacing Module with TH-R, TH-W Terminals

On modules that do not have a vent damper plug, the thermostat must be connected between the transformer and the 24V terminal on the module. To change out a module with TH-R, TH-W terminals:

1. Remove the wires from the 25V(2) and TH-R terminals on the old module. Connect these two wires with a solderless connector.
2. Tag and remove the remaining wires from the old module.
3. Remove the old module and mount the new one in the same location.
4. Reconnect the remaining wires as shown in Table 4.
5. Increase the thermostat anticipator setting by 0.2A.

Table 4. Terminal Cross Reference.

Terminal on Old Module:	Terminal on New Module
25V (1)	24V (GND)
TH-W	24V
MV	MV
MV/PV	MV/PV
PV	PV
GND (Burner)	GND (Burner)

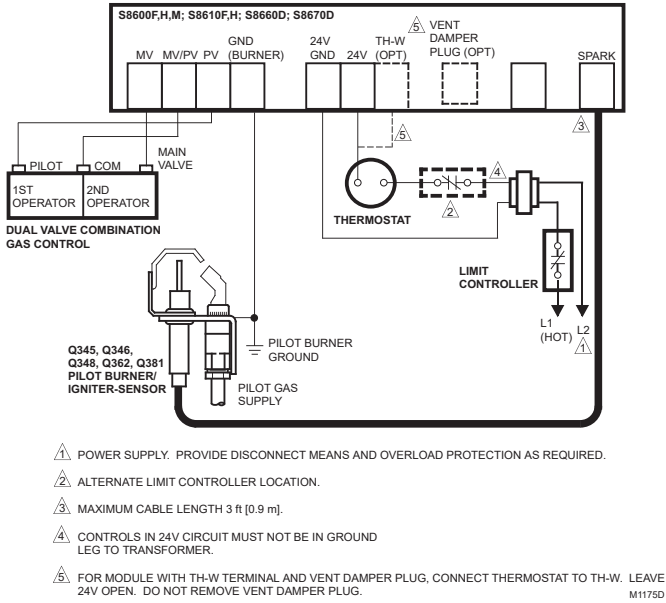

Fig. 1. S8600F,H,M; S8610F,H; S8660D; S8670D Connections in a Heating System with an Atmospheric Burner.

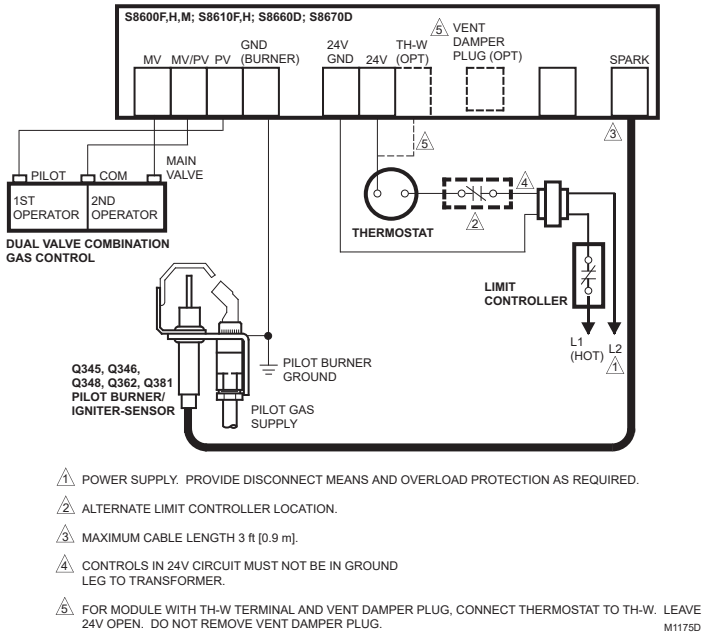

Fig. 2. S8600F,H,M; S8610F,H with a Vent Damper Plug in a Heating System with an Atmospheric Burner and a D80D Vent Damper.

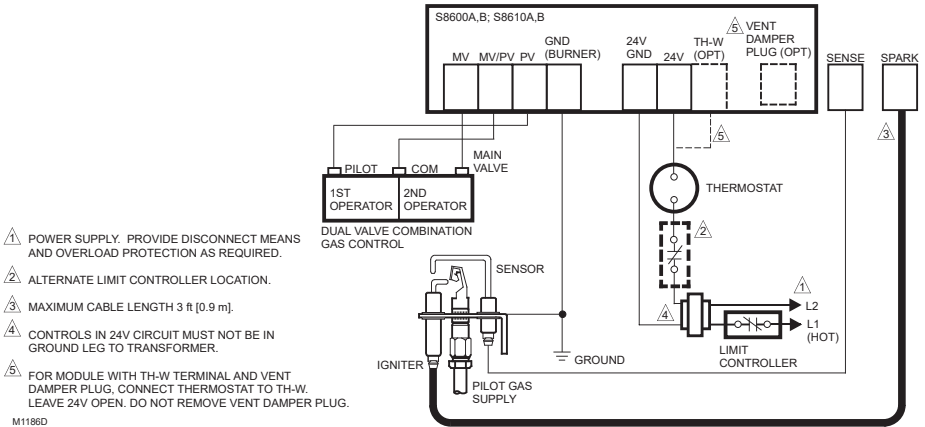

Fig. 3. S8600A,B; S8610A,B Connections in a Heating System with an Atmospheric Burner.

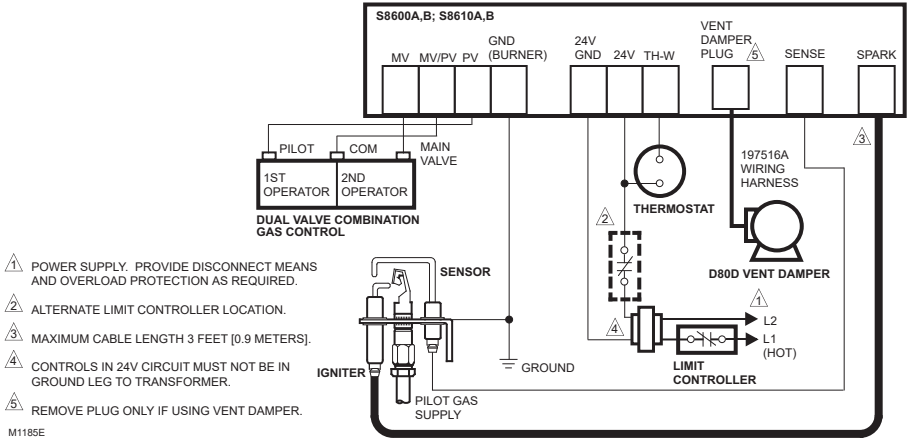

Fig. 4. S8600A,B; S8610A,B with Vent Damper Plug in an Atmospheric Burner Heating System with a D80D Vent Damper.

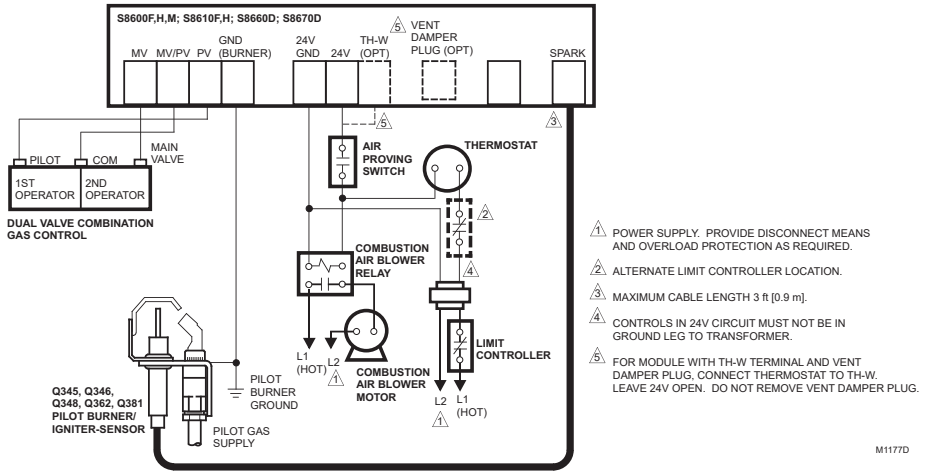

Fig. 5. S8600F,H,M; S8610F,H; S8660D; S8670D Connections in a Heating System with Power-Assisted Combustion.

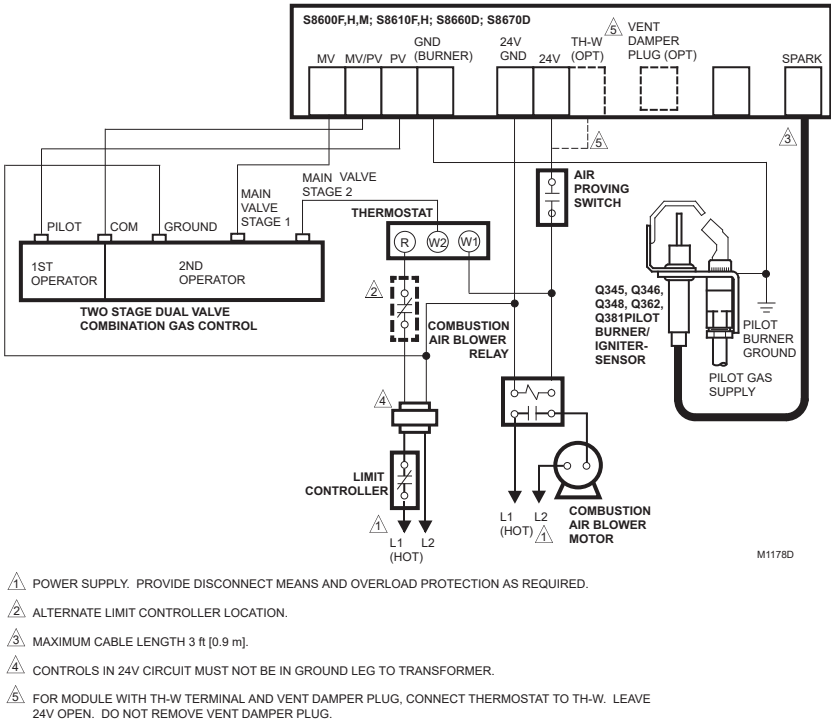
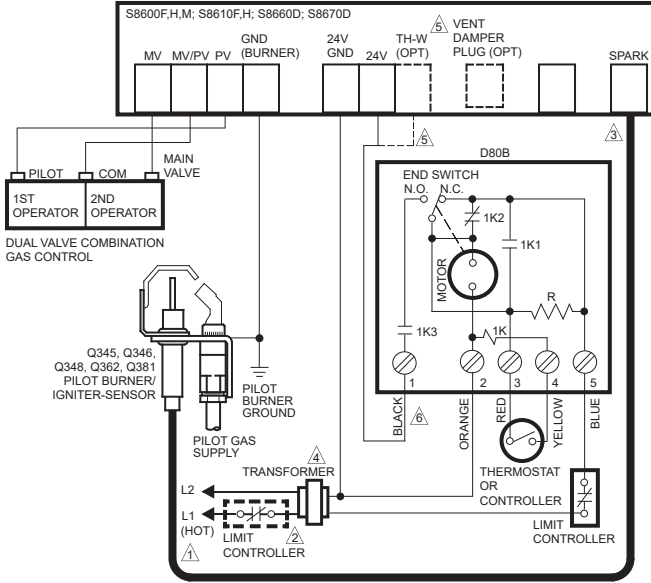

Fig. 6. S8600F,H,M; S8610F,H; S8660D; S8670D Connections in a Heating System with a Two-Stage Gas Control and Power-Assisted Combustion.



- ⚠ POWER SUPPLY. PROVIDE DISCONNECT MEANS AND OVERLOAD PROTECTION AS REQUIRED.
- ⚠ ALTERNATE LIMIT CONTROLLER LOCATION.
- ⚠ MAXIMUM CABLE LENGTH 3 ft [0.9 m].
- ⚠ CONTROLS IN 24V CIRCUIT MUST NOT BE IN GROUND LEG TO TRANSFORMER.
- ⚠ FOR MODULE WITH TH-W TERMINAL AND VENT DAMPER PLUG, CONNECT THERMOSTAT TO TH-W. LEAVE 24V OPEN. DO NOT REMOVE VENT DAMPER PLUG.
- ⚠ COLORS REFER TO WIRE HARNESS, IF USED.

M1180D

Fig. 7. S8600F,H,M; S8610F,H; S8660D; S8670D in a Heating System with an Atmospheric Burner and a D80D Vent Damper.

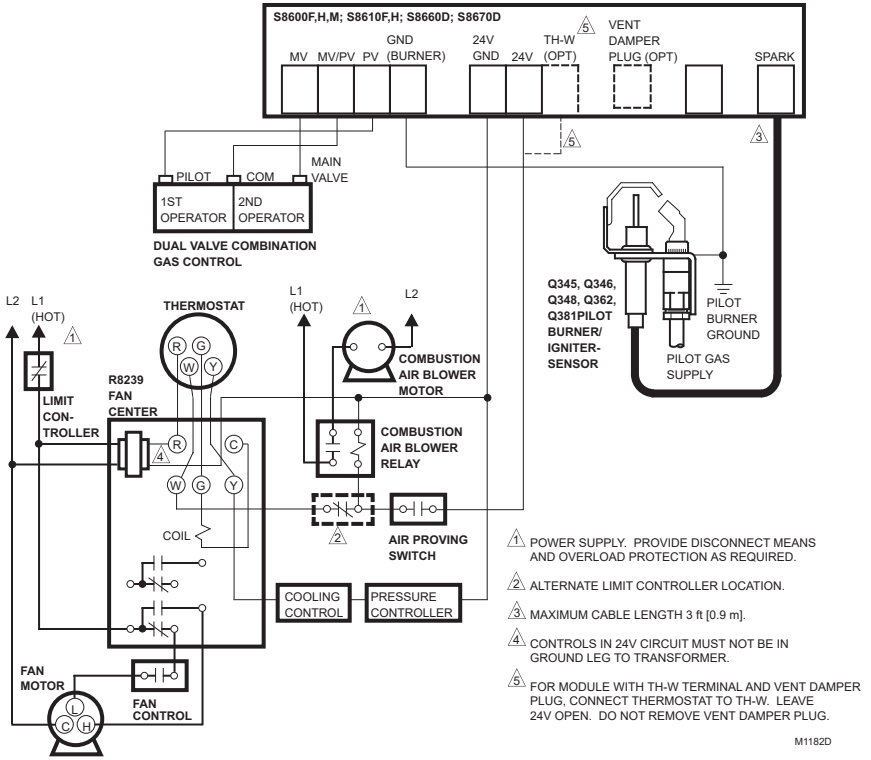
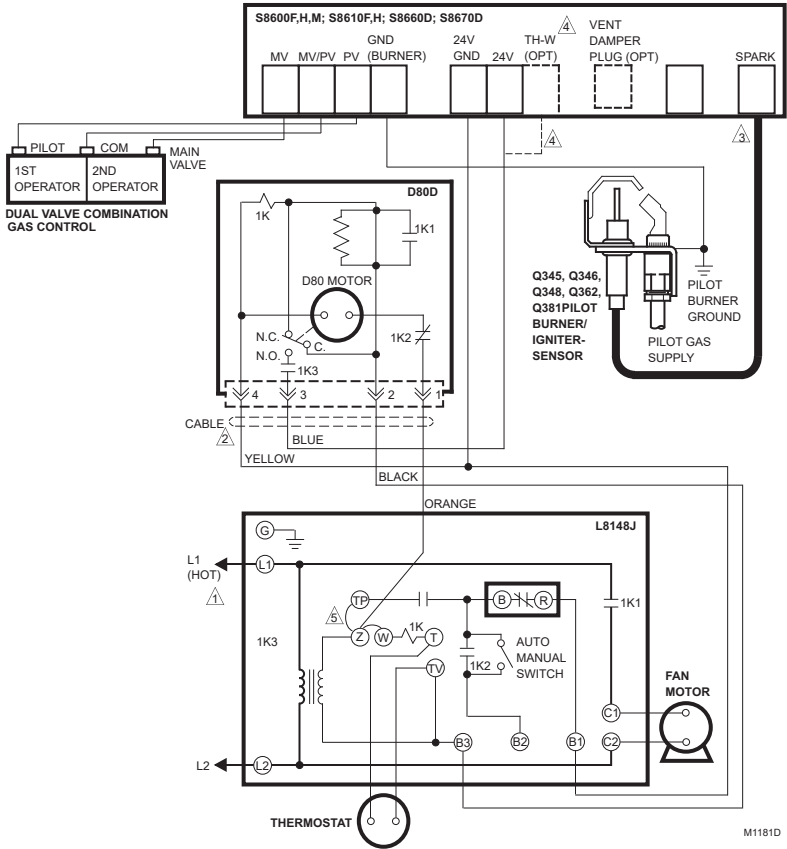

Fig. 8. S8600F,H,M; S8610F,H; S8660D; S8670D Connections in a Heating-Cooling System with Power-Assisted Combustion.



M1181D

- ⚠ POWER SUPPLY. PROVIDE DISCONNECT MEANS AND OVERLOAD PROTECTION AS REQUIRED.
- ⚠ CUT PLUG OFF MODULE END OF D80D WIRE HARNESS. CONNECT LEADWIRE COLORS AS SHOWN.
- ⚠ MAXIMUM CABLE LENGTH 3 ft [0.9 m].
- ⚠ FOR MODULE WITH TH-W TERMINAL AND VENT DAMPER PLUG, CONNECT THERMOSTAT TO TH-W. LEAVE 24V OPEN. DO NOT REMOVE VENT DAMPER PLUG.
- ⚠ LEAVE TP-Z AND Z-W JUMPERS IN PLACE.

Fig. 9. S8600F,H,M; S8610F,H; S8660D; S8670D Connections in a Hydronic Heating System with a D80D Vent Damper.

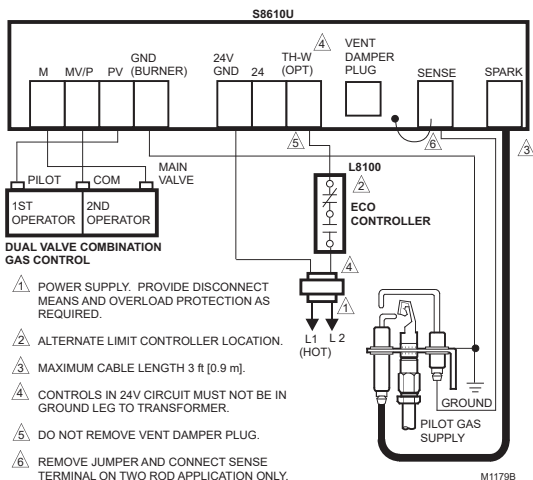

Fig. 10. S8600F,H,M; S8610F,H; S8660D; S8670D Connections in a Commercial Water Heater Control System.

CHECKOUT

Check out the gas control system:

- At initial installation of the appliance.
- As part of regular maintenance procedures. Maintenance intervals are determined by the application. See **PLANNING THE INSTALLATION**, page 1, for more information.
- As the first step in troubleshooting.
- Any time work is done on the system.

⚠ WARNING

Fire or Explosion Hazard.
Can cause severe injury, death, or property damage.

1. If you smell gas or suspect a gas leak, turn off gas at manual service valve and evacuate the building. Do not try to light any appliance, do not touch any electrical switch or telephone in the building until you are sure no spilled gas remains.
2. Gas leak test must be done as described in Steps 1 and 5 below on initial installation and any time work is done involving the gas piping.

STEP 1: Perform Visual Inspection.

- With power off, make sure all wiring connections are clean and tight.
- Turn on power to appliance and ignition module.
- Open manual shutoff valves in the gas line to the appliance.
- Do gas leak test ahead of gas control if piping has been disturbed.

GAS LEAK TEST: Paint pipe joints with rich soap and water solution. Bubbles indicate gas leak. Tighten joints to stop leak. Recheck with soap and water.

STEP 2: Review Normal Operating Sequence and Module Specifications.

- See **OPERATION**, page 12 and **APPLICATION**, page 1.

STEP 3: Reset the Module.

- Turn the thermostat to its lowest setting.

- Wait one minute.

As you do Steps 4 and 5, watch for points where operation deviates from normal. Refer to Troubleshooting Chart to correct problem.

STEP 4: Check Safety Shutoff Operation.

This step applies to lockout and continuous retry modules only.

- Turn gas supply off.
- Set thermostat or controller above room temperature to call for heat.
- Watch for spark at pilot burner either immediately or following prepurge. See device label.
- Time spark from start to shutoff. See device label. On S8600M, wait 6 min. nominal. Ignition sequence should start again followed by shutoff after 90 sec. max.
- Open manual gas cock and make sure no gas is flowing to pilot or main burner.
- Set thermostat below room temperature and wait one minute before continuing.

STEP 5: Check Normal Operation.

- Set thermostat or controller above room temperature to call for heat.
- Make sure pilot lights smoothly when gas reaches the pilot burner.
- Make sure main burner lights smoothly without flashback.
- Make sure burner operates smoothly without floating, lifting, or flame rollout to the furnace vestibule or heat buildup in the vestibule.

If gas line has been disturbed, complete gas leak test.

GAS LEAK TEST: Paint gas control gasket edges and all pipe connections downstream of gas control, including pilot tubing connections, with rich soap and water solution. Bubbles indicate gas leaks. Tighten joints and screws or replace component to stop gas leak. Recheck with soap and water.

- Turn thermostat or controller below room temperature. Make sure main burner and pilot flames go out.

Figures 11 and 12 summarize the normal operating sequences of the modules.

OPERATION

Module operation can be conveniently divided into two phases for S8600, S8610 and three for S8660, S8670. The phases are:

- Prepurge (S8660, S8670 only)
- Trial for ignition (all models)
- Main burner operation (all models)

Prepurge (S8660, S8670 ONLY)

When the S8660 is used in a fan-assisted combustion system, the combustion air blower starts on a call for heat. On proof of airflow, the air proving switch closes and energizes the S8660, S8670. When the module is used in an atmospheric system, the call for heat energizes the module.

In either case, the module first initiates a 45 sec. delay to allow system prepurge. After prepurge, the module starts the pilot ignition sequence.

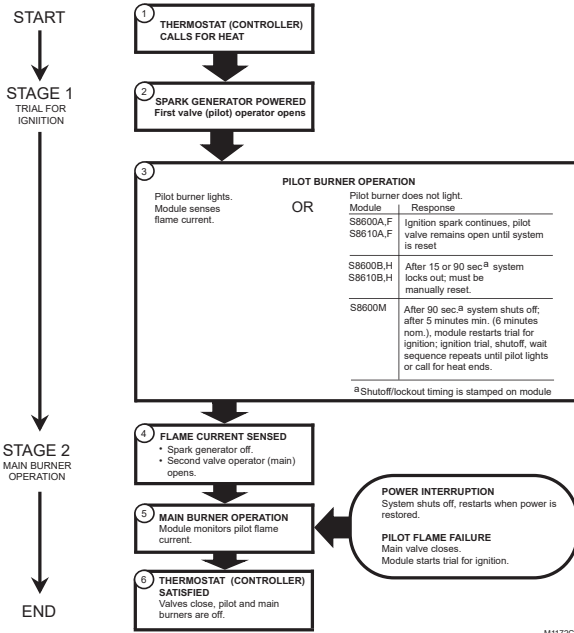

Fig. 11. S8600, S8610 Normal Operating Sequence.

Trial for Ignition

Pilot Ignition

Following prepurge timing (S8660, S8670), or on the call for heat (S8600, S8610), the module energizes the first main valve operator. The first main valve opens, which allows gas to flow to the pilot burner. At the same time, the electronic spark generator in the module produces over 10,000 volt spark pulse output. The voltage generates a spark at the igniter (S8600A,B; S8610A,B) or igniter-sensor (S8600F,H,M; S8610F,H; S8660; S8670) that lights the pilot.

If the pilot does not light, or the pilot flame current is not at least 1.0 μ A and steady, the module will not energize the second (main) valve and the main burner will not light. S8600A,F; S8610A,F will continue to spark as long as the thermostat calls for heat, or until the pilot lights.

Safety Lockout (S8600B,H; S8610B,H; S8660D; S8670D)

These modules provide 100 percent shutoff and safety lockout. A timer in these models starts timing the moment the trial for ignition starts. Ignition spark continues only until the timed trial for ignition period ends. Then the module goes into safety lockout. Lockout de-energizes the first main valve operator and closes the first main (pilot) valve in the gas control, stopping pilot gas flow. The control system must be reset by setting the thermostat below room temperature for one minute or by turning off power to the module for one minute.

Safety Shutoff with Continuous Retry (S8600M)

The S8600M provides 100 percent gas shutoff, followed by retry for ignition. Operation on ignition failure is the same as lockout modules, except that a timer starts timing immediately following shutoff. Six minutes nom. (five minutes min.) after shutoff, the module restarts the ignition sequence. The ignition trial, shutoff, wait sequence continues until either the pilot lights or the thermostat is set below room temperature to end the call for heat. The module can also be reset by setting down the thermostat for one minute.

Main Burner Operation

When the pilot flame is established, a flame rectification circuit is completed between the sensor and burner ground. The flame sensing circuit in the module detects the flame current, shuts off the spark generator and energizes the second main valve operator. The second main valve opens and gas flows to the main burner, where it is ignited by the pilot burner. On lockout models, the flame current also holds the safety lockout timer in the reset (normal) operating condition.

When the call for heat ends, both valve operators are de-energized, and both valves in the gas control close.

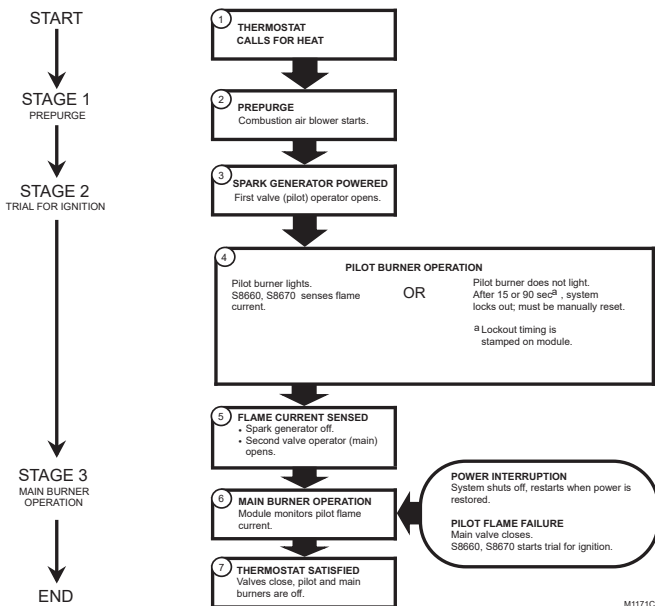

Fig. 12. S8660, S8670 Normal Operating Sequence.

TROUBLESHOOTING

IMPORTANT

1. The following service procedures are provided as a general guideline. Follow appliance manufacturer service instructions, if available.
2. On lockout and retry models, meter readings between gas control and ignition module must be taken within the trial for ignition period. Once the ignition module shuts off, lockout models must be reset by setting the thermostat down for at least one minute before continuing. On retry models, wait for retry or reset at the thermostat.
3. If any component does not function properly, make sure it is correctly installed and wired before replacing it.
4. The ignition module cannot be repaired. If it malfunctions, it must be replaced.
5. Only trained, experienced service technicians should service intermittent pilot systems.

Perform the checkout on page 11 as the first step in troubleshooting. Then check the appropriate troubleshooting guide (Figures 14 or 15) and the schematic diagram (Figures 16 or 17) to pinpoint the cause of the problem. If troubleshooting indicates an ignition problem, see Ignition System Checks below to isolate and correct the problem.

Following troubleshooting, perform the checkout procedure again to be sure system is operating normally.

Ignition System Checks

STEP 1: Check ignition cable.

Make sure:

1. Ignition cable does not run in contact with any metal surfaces.
2. Ignition cable is no more than 36 in. (0.9 m) long.
3. Connections to the ignition module and to the igniter or igniter-sensor are clean and tight.
4. Ignition cable provides good electrical continuity.

STEP 2: Check ignition system grounding. *Nuisance shutdowns are often caused by a poor or erratic ground.*

1. A common ground, usually supplied by the pilot burner bracket, is required for the module and the pilot burner/igniter-sensor.
 - a. Check for good metal-to-metal contact between the pilot burner bracket and the main burner.
 - b. Check the ground lead from the GND(BURNER) terminal on the module to the pilot burner. Make sure connections are clean and tight. If the wire is damaged or deteriorated, replace it with No. 14-18 gauge, moisture-resistant, thermoplastic insulated wire with 221° F (105° C) minimum rating.
 - (1) Check the ceramic flame rod insulator for cracks or evidence of exposure to extreme heat, which can permit leakage to ground. Replace pilot burner/igniter-sensor and provide shield if necessary.
 - (2) If flame rod or bracket are bent out of position, restore to correct position.

STEP 3: Check spark ignition circuit. *You will need a short jumper wire made from ignition cable or other heavily insulated wire.*

1. Close the manual gas valve.
2. Disconnect the ignition cable at the SPARK terminal to the module.

WARNING

Electrical Shock Hazard.
Can cause severe injury, death or property damage.

When performing the following steps, do not touch the stripped end of jumper or SPARK terminal. The ignition circuit generates over 10,000 volts and electrical shock can result.

3. Energize the module and immediately touch one end of the jumper firmly to the GND terminal on the module. Move the free end of the jumper slowly toward the SPARK terminal until a spark is established.
4. Pull the jumper slowly away from the terminal and note the length of the gap when sparking stops. Check Table 5 below.





Table 5. Checking Arc Length.

Arc Length	Action
No arc or arc less than 1/8 in. (3 mm)	Check external fuse, if provided. Verify power at module input terminal. Replace module if fuse and power okay.
Arc 1/8 in. (3 mm) or longer.	Voltage output is okay.

STEP 4: Check pilot and main burner lightoff.

1. Set the thermostat to call for heat.
2. Watch the pilot burner during the ignition sequence. See if.
 - a. Ignition spark continues after the pilot is lit.
 - b. The pilot lights and the spark stops, but main burner does not light.
 - c. *S8600B,H,M; S8610B,H; S8660D; S8670D only:* The pilot lights, the spark stops and main burner lights, but the system shuts down.
3. If so, ensure adequate flame current as follows.

- a. Turn off furnace at circuit breaker or fuse box.
- b. Clean the flame rod with emery cloth.
- c. Make sure electrical connections are clean and tight. Replace damaged wire with moisture-resistant No. 18 wire rated for continuous duty up to 221° F (105° C).
- d. Check for cracked ceramic insulator, which can cause short to ground, and replace igniter-sensor if necessary.
- e. At the gas control, disconnect main valve wire from the TH or MV terminal.
- f. Turn on power and set thermostat to call for heat. The pilot should light but the main burner will remain off because the main valve actuator is disconnected.
- g. Check the pilot flame. Make sure it is blue, steady and envelops 3/8 to 1/2 in. (10 to 13 mm) of the flame rod. See Fig. 13 for possible flame problems and their causes.

APPEARANCE	CAUSE
SMALL BLUE FLAME 	CHECK FOR LACK OF GAS FROM: • CLOGGED ORIFICE FILTER • CLOGGED PILOT FILTER • LOW GAS SUPPLY PRESSURE • PILOT ADJUSTMENT AT MINIMUM
LAZY YELLOW FLAME 	CHECK FOR LACK OF AIR FROM: • DIRTY ORIFICE • DIRTY LINT SCREEN, IF USED • DIRTY PRIMARY AIR OPENING, IF THERE IS ONE • PILOT ADJUSTMENT AT MINIMUM
WAVING BLUE FLAME 	CHECK FOR: • EXCESSIVE DRAFT AT PILOT LOCATION • RECIRCULATING PRODUCTS OF COMBUSTION
NOISY LIFTING BLOWING FLAME 	CHECK FOR: • HIGH GAS PRESSURE
HARD SHARP FLAME 	THIS FLAME IS CHARACTERISTIC OF MANUFACTURED GAS CHECK FOR: • HIGH GAS PRESSURE • ORIFICE TOO SMALL

M3272A

Fig. 13. Examples of Unsatisfactory Pilot Flames.

- h. If necessary, adjust pilot flame by turning the pilot adjustment screw on the gas control clockwise to decrease or counterclockwise to increase pilot flame. Following adjustment, always replace pilot adjustment cover screw and tighten firmly to assure proper gas control operation.
- i. Set thermostat below room temperature to end call for heat.

4. Recheck ignition sequence as follows.
 - a. Reconnect main valve wire.
 - b. Set thermostat to call for heat.
 - c. Watch ignition sequence at burner.
 - d. If spark still doesn't stop after pilot lights, replace ignition module.
- e. If main burner doesn't light or if main burner lights but system locks out, check module, ground wire and gas control as described in appropriate troubleshooting chart, Figures 14 or 15.

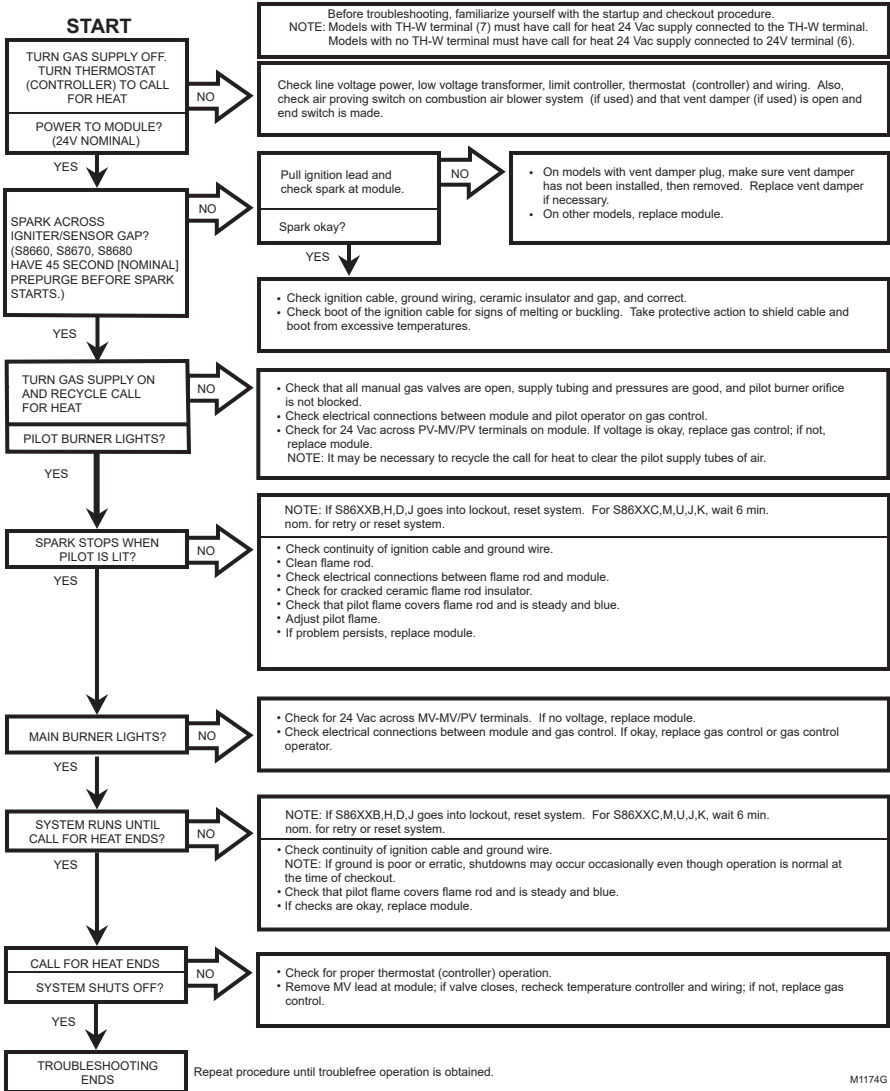
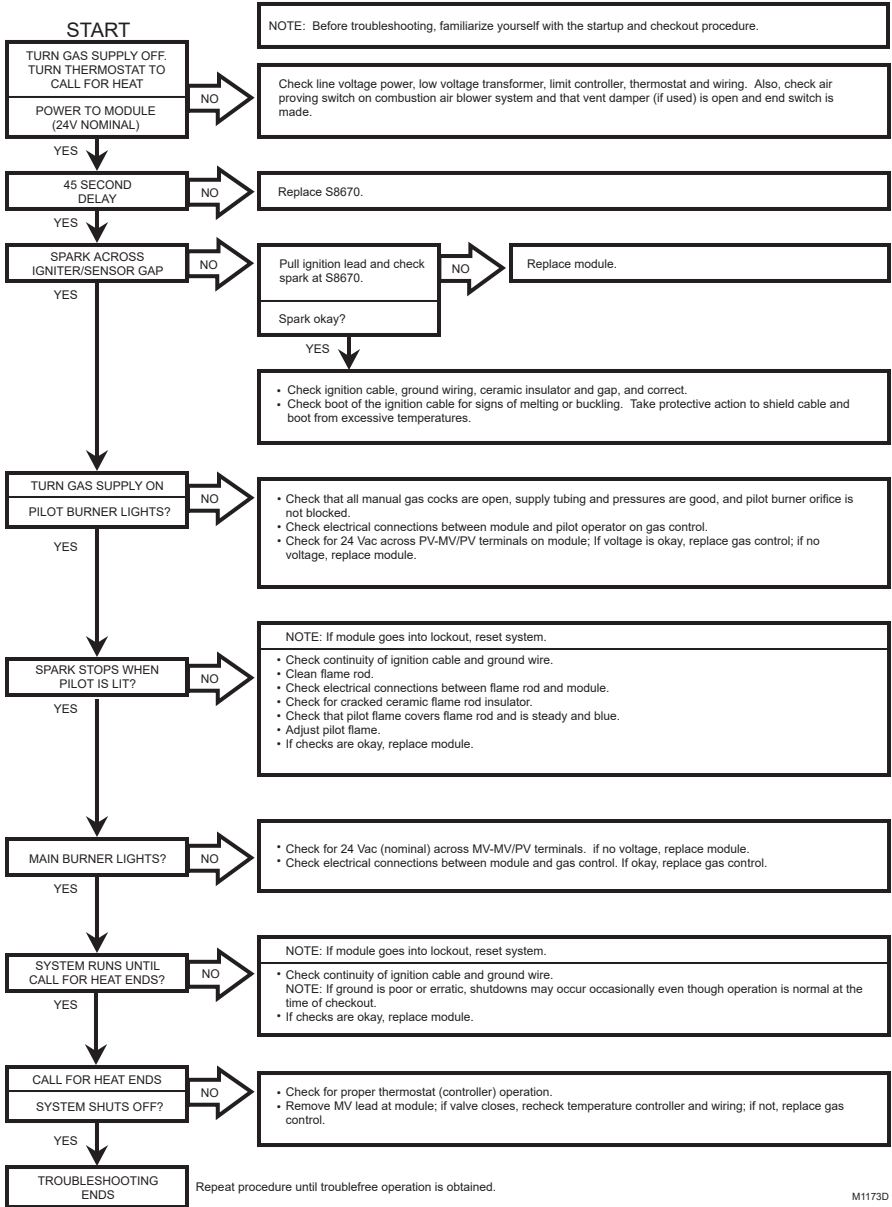

Fig. 14. S8600, S8610 Troubleshooting Guide.



M1173D

Fig. 15. S8660, S8670 Troubleshooting Guide.

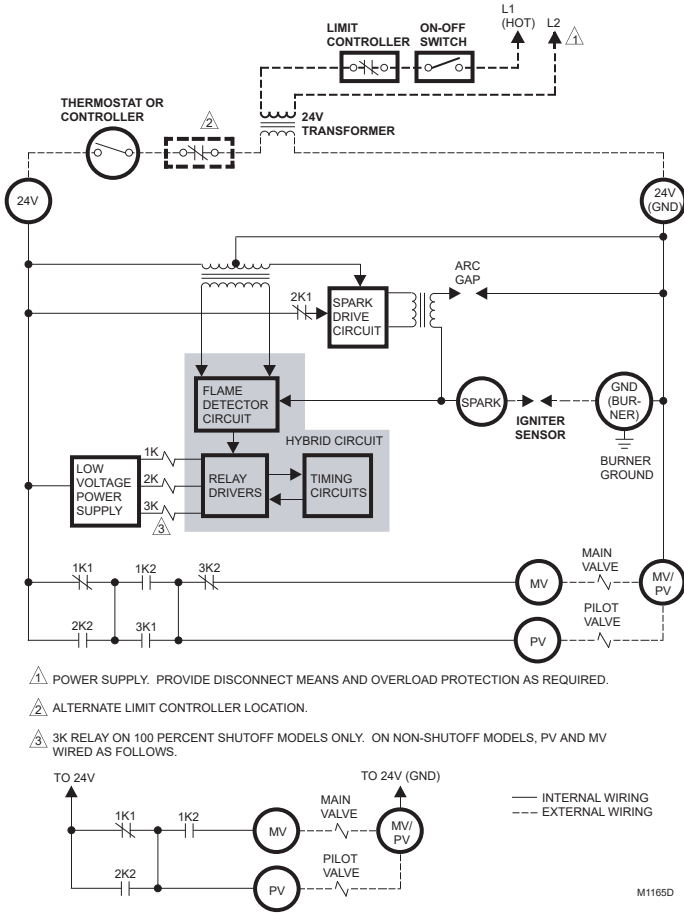
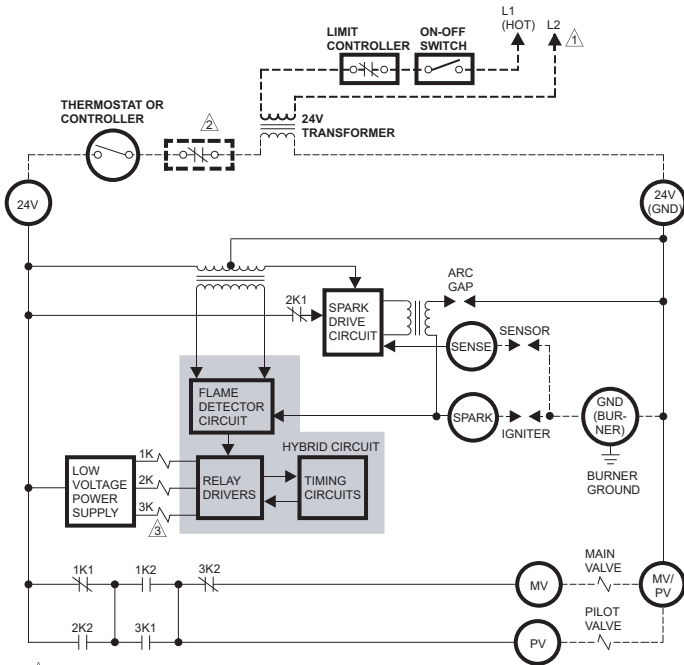
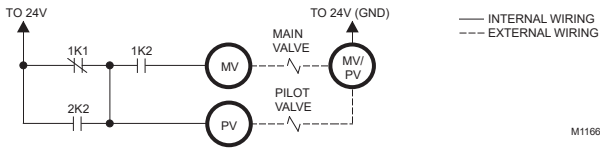

Fig. 16. Representative Schematic for S8600F,H,M; S8610F,H: See Fig. 1 for Hookup. S8660 and S8670 are Similar Except the Timing Circuit includes a Purge Timer. See Fig. 6 for Hookup.



- ⚠ POWER SUPPLY. PROVIDE DISCONNECT MEANS AND OVERLOAD PROTECTION AS REQUIRED.
- ⚠ ALTERNATE LIMIT CONTROLLER LOCATION.
- ⚠ 3K RELAY ON 100 PERCENT SHUTOFF MODELS ONLY. ON NON-SHUTOFF MODELS, PV AND MV WIRED AS FOLLOWS.



M1166D

Fig. 17. Representative Schematic for S8600A,B; S8610A,B: See Fig. 3 for Hookup.

ANSI STANDARDS

EXHIBIT A RECOMMENDED PROCEDURE FOR SAFETY INSPECTION OF AN EXISTING APPLIANCE INSTALLATION AS A PRELIMINARY STEP TO APPLYING AN AUTOMATIC INTERMITTENT PILOT SYSTEM

The following procedure is intended as a guide to aid in determining that an appliance is properly installed and is in a safe condition for continuing use.

This procedure is predicated on central furnace and boiler installations equipped with an atmospheric gas burner(s) and not of the direct vent type. It should be recognized that generalized test procedures cannot anticipate all situations. Accordingly, in some cases, deviations from this procedure may be necessary to determine safe operation of the equipment.

- a. This procedure should be performed prior to any attempt at modification of the appliance or the installation.
- b. If it is determined there is a condition that could result in unsafe operation, the appliance should be shut off and the owner advised of the unsafe condition.

The following steps should be followed in making the safety inspection:

1. Conduct a Gas Leakage Test of the appliance piping and control system downstream of the shutoff valve in the supply line to the appliance.
 2. Visually inspect the venting system for proper size and horizontal pitch and determine there is no blockage or restrictions, leakage or corrosion or other deficiencies that could cause an unsafe condition.
 3. Shut off all gas to the appliance and shut off any other fuel-burning appliances within the same room. Use the shutoff valve in the supply line to each appliance.
 4. Inspect burners and crossovers for blockage and corrosion.
 5. Applicable only to warm air heating appliances. Inspect heat exchangers for cracks, openings or excessive corrosion.
 6. Applicable only to boilers. Inspect for evidence of water or combustion product leaks.
 7. Insofar as is practical, close all building doors and windows and all doors between the space in which the appliance is located and other spaces of the building. Turn on clothes dryers. Turn on any exhaust fans, such as range hoods and bathroom exhausts, so they will operate at maximum speed.
8. Do not operate a summer exhaust fan. Close fireplace dampers. If, after completing steps 7 through 12, it is believed sufficient combustion air is not available, refer to 1.3.4 of the National Fuel Gas Code (Z223.1) for guidance.
 9. Place in operation the appliance being inspected. Follow the lighting instructions. Adjust thermostat so appliance will operate continuously.
 10. Determine that the pilot is burning properly and that main burner ignition is satisfactory by interrupting and re-establishing the electrical supply to the appliance in any convenient manner.
 - a. Determine manifold pressure in order to match input after the new control is installed.
 11. Visually determine that main burner gas is burning properly; i.e., no floating, lifting or flashback. Adjust the primary air shutter(s) as required.
 - a. If appliance is equipped with high and low flame control or flame modulation, check for proper main burner operation at low flame.
 12. Test for spillage at the draft hood relief opening after five minutes of main burner operation. Use a draft gauge, the flame of a match or candle, or smoke from a cigarette, cigar, or pipe.
 13. Return doors, windows, exhaust fans, fireplace dampers and all other fuel-burning appliances to their previous conditions of use.
 14. Applicable only to warm air heating appliances. Check both limit controller and fan controller for proper operation. Limit controller operation can be checked by temporarily disconnecting the electrical supply to the blower motor and determining that the limit control acts to shut off the main burner gas.
 - a. Applicable only to boilers:
 - a. Determine that the circulating water pumps are in operating condition.
 - b. Test low water cutoffs, automatic feed controls, pressure and temperature limit controls and relief valves in accordance with the manufacturer recommendations and instructions to determine they are in operating condition.

EXHIBIT A OF ANSI STANDARD Z21.71 FOR AUTOMATIC INTERMITTENT PILOT IGNITION SYSTEMS FOR FIELD INSTALLATION

EXHIBIT B
PROCEDURE FOR INSTALLING AUTOMATIC INTERMITTENT PILOT SYSTEMS

Prior to beginning this procedure, a preliminary examination of the appliance and the automatic intermittent pilot system should be made to determine that the automatic intermittent pilot system can be properly applied to the appliance.

This procedure is intended as a guide to aid in safely installing a listed automatic intermittent pilot system on an existing listed appliance equipped with an atmospheric gas burner(s) and not of the direct vent type.

This procedure is based on the assumption that the history of the specific installation has been one of safe and satisfactory operation.

This procedure is predicated on central furnace and boiler installations, and it should be recognized that generalized procedures cannot anticipate all situations. Accordingly, in some cases, deviation from this procedure may be necessary to determine safe operation of the equipment.

The following steps should be followed in making the modifications:

1. Perform a safety inspection of the existing appliance installation. See Exhibit A for a recommended procedure for such a safety inspection.
2. Shut off all gas and electricity to the appliance. To shut off gas, use the shutoff valve in the supply line to the appliance. Do not use the shutoff valve that is provided as part of a combination control.
3. Install the automatic intermittent pilot system in strict accordance with the manufacturer's installation instructions.
4. Turn on all gas and electricity to the appliance.
5. Determine that the appliance transformer has adequate capacity by following the steps outlined below:
 - a. Compute the approximate current draw by adding the current draw of the automatic intermittent pilot system to (1) the current draw of the associated valving, and (2) the current draw of any relays or other devices operated by the transformer.
 - b. Multiply the total current draw as computed above by 24V to determine the total VA (volt-ampere) required.
 - c. The total VA (volt-ampere) required should be equal to or less than the VA rating of the transformer.
 - d. If the total VA (volt-ampere) required is greater than the VA rating of the transformer, the transformer must be replaced with a Class 2 transformer of adequate rating.
6. Check the heat anticipator in the comfort thermostat to determine if it is properly adjusted to the current draw of the control system. Follow the thermostat manufacturer's instructions.
7. Make certain wiring connections are tight and wires are positioned and secured so they will not be able to contact high temperature locations.
8. Conduct a Gas Leakage Test of the appliance piping and control system downstream of the shutoff valve in the supply line to the appliance.
9. Adjust the thermostat to its highest temperature setting, and test manifold pressure and adjust the pressure regulator to match original input as required (refer to Exhibit A, Step 9b).
 - a. Visually determine that main burner is burning properly; i.e., no floating, lifting, or flashback. Adjust the primary air shutters as required.
10. If the appliance is equipped with high and low flame control or flame modulation, check for proper main burner operation at both high and low flame.
11. Determine that the pilot is igniting and burning properly and that main burner ignition is satisfactory by interrupting and re-establishing the electrical supply to the appliance in any convenient manner. Make this determination with the appliance burner both cold and hot. Perform this step as many times as is necessary to satisfy yourself that the automatic intermittent pilot system is operating properly.
12. Test the pilot safety device (1) to determine if it is operating properly, and (2) for turndown characteristics according to the manufacturer's installation instructions. No adjustment should be made other than those recommended by the system manufacturer.
13. Sequence the appliance through at least three operating cycles.
14. Applicable only to furnaces. Check both the limit controller and the fan controller for proper operation. Limit control operation can be checked by blocking the circulating air inlet or temporarily disconnecting the electrical supply to the blower motor and determining that the limit controller acts to shut off the main burner gas.
15. Applicable only to boilers:
 - a. Determine that the circulating water pumps are in operating condition.
 - b. Test low water cutoffs, automatic feed water controls, pressure and temperature limit controllers and relief valves in accordance with the manufacturer's recommendations to determine they are in operating condition.
16. Add the labels (see 1.6.1-n and -o) on the appliance.

EXHIBIT B OF ANSI STANDARD Z21.71 FOR AUTOMATIC INTERMITTENT PILOT IGNITION SYSTEMS FOR FIELD INSTALLATION



Resideo Technologies, Inc.
 1985 Douglas Drive North, Golden Valley, MN 55422
 1-800-468-1502

www.resideo.com 69-0463-03 M.S. Rev. 09-20 | Printed in United States