

VS8420 Millivolt Gas Valve

INSTALLATION INSTRUCTIONS

APPLICATION

The VS8420 Millivolt Gas Valve is compact and has a 60,000 Btuh capacity (1 in. pressure drop for straight-through configuration). The design makes it ideal for fireplace and space heating applications.

SPECIFICATIONS

Main Gas Connection: Valve: 3/8 in. NPT thread.

Pilot Gas Connection and Flow:

Connection Size: 7/16-24 UNS.

Flow: 1700 Btuh at 4.0 in. wc pressure drop.

Thermocouple and Pilot Threads: Metric and UNS.

Ambient Temperature Range:

0°F to 175°F (-18°C to 79°C).

Option for 225°F (107°C).

Pressure Regulation (Standard Regulator):

Servo regulator with adjustable outlet pressure.

Natural Gas: 3.5 in. wc, typical.

LP: 11 in. wc, typical.

Regulator Adjustments (Standard Regulator):

Natural Gas: 1/2 in. field adjustable.

LP: 8 in. to 12 in. field adjustable.

Voltage: VS8420: 70 mV generator, 30 mV thermocouple.

Approvals:

International Approval Services (IAS) Certificate: C203002.

European Community (CE) Certificate: Applied for.

INSTALLATION

When Installing this Product:

1. Read these instructions carefully. Failure to follow them could damage the product or cause a hazardous condition.
2. Check the ratings given in the instructions and on the product to make sure the product is suitable for your application.
3. Installer must be a trained, experienced service technician.
4. After installation is complete, check out product operation as provided in these instructions.

⚠️ WARNING

Oxygen Depletion Hazard.

Can cause injury or death due to asphyxiation.

Use only vented gas valve models on vented appliances. Use only unvented gas valve models on unvented appliances.

⚠️ WARNING

Fire or Explosion Hazard.

Can cause property damage, severe injury or death.

Follow these instructions exactly:

1. Turn off gas supply at the appliance service valve before starting installation, and perform a Gas Leak Test after the installation is complete.
2. Always install the sediment trap in the gas supply line to prevent contamination of the gas valve.
3. Do not force the gas valve control knob. Use only your hand to turn the control knob. If the knob does not operate by hand, the valve should be replaced by a qualified service technician.



⚠️ WARNING

Electrical Shock or Equipment Damage Hazard.
Can cause severe injury or death, or short equipment circuitry.
 Disconnect all power supplies before installation.

⚠️ CAUTION

Equipment Damage.
Can burn out heat anticipator in thermostat.
 Never apply a jumper across or short the valve coil terminals.

IMPORTANT

These gas valves are shipped with protective seals over the inlet and outlet tapings. Do not remove the seals until ready to connect the piping.

Follow the appliance manufacturer instructions, if available; otherwise, use these instructions.

Converting Between Natural and LP Gas

⚠️ WARNING

Fire or Explosion Hazard.
Can cause property damage, severe injury or death.
 Do not use a gas valve set for natural gas on an LP gas system or a gas valve set for LP gas on a natural gas system. When making conversion, change the main pilot burner orifice to meet the appliance manufacturer specifications.

VS8420A gas controls with Convertible High/Low regulator can be converted from one gas to the other with a conversion kit (ordered separately). Order part no. 395991 to convert from natural (manufactured) to LP (manufactured) gas. Order part no. 395992 to convert from LP (manufactured) to natural (manufactured) gas.

VS8420E gas controls with Convertible High/Low regulator can be converted from one gas to the other with a conversion kit (ordered separately). Order part no. 396087 to convert from LP (manufactured) to natural (manufactured) gas. Order part no. 396087-2 to convert from natural (manufactured) to LP gas.

High/Low regulator models VS8420D cannot be converted.

VS8420R Convertible Pressure Regulators

Gas valves with suffix letter R are convertible pressure regulator models. They can be converted from natural gas to LP or from LP to natural gas without a converter.

Before converting the gas valve from one gas to another, check the gas valve label and the appliance manufacturer rating plate to make sure the pressure regulator setting (factory set) meets the appliance manifold requirements after conversion.

NOTE: Convertible pressure regulator models (suffix R) do not have field-adjustable regulators. The natural gas and LP settings are factory-set.

CONVERTING THE GAS VALVE

If the factory pressure regulator setting meets the appliance manifold requirement, convert the gas valve as follows (see Fig. 1):

1. Remove the black thread protective cap.
2. Remove the conversion flip cap by turning it counterclockwise.
3. Invert the conversion flip cap so that the letters and associated arrow for the gas type appropriate for the appliance application are face down toward the valve. NAT is for natural gas and LP is for liquefied petroleum.
4. Tighten the conversion flip cap by turning it clockwise.

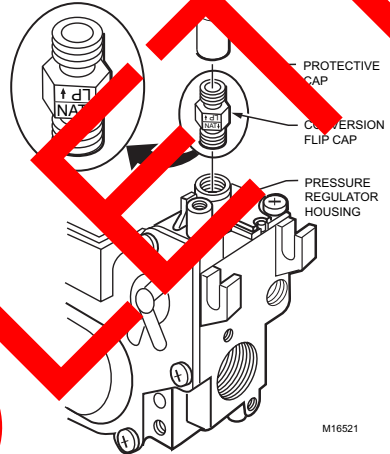

Fig. 1. Converting the gas valve.

Location

Locate the combination gas valve where it cannot be affected by steam cleaning, high humidity, dripping water, corrosive chemicals, dust or grease accumulation or excessive heat. To assure proper operation, follow these guidelines:

- Locate gas valve in a well-ventilated area.
- Mount gas valve high enough to avoid exposure to flooding or splashing water.
- Assure the ambient temperature does not exceed the ambient temperature ratings for each component.
- Cover gas valve if appliance is cleaned with water, steam, or chemicals or to avoid dust and grease accumulation.
- Avoid locating gas valve where it can be exposed to corrosive chemical fumes or dripping water.

Install Piping to Gas Valve

All piping must comply with local codes and ordinances or with the National Fuel Gas code (ANSI Z223.1 NFPA No. 54), whichever applies. Tubing installation must comply with approved standards and practices.

1. Use new, properly reamed pipe free from chips. When tubing is used, assure the ends are square, deburred and clean. All tubing bends must be smooth and without deformation.
2. Run pipe or tubing to the valve. If tubing is used, obtain a tube-to-pipe coupling to connect the tubing to the valve.
3. Install sediment trap in the supply line to the gas valve. See Fig. 2.

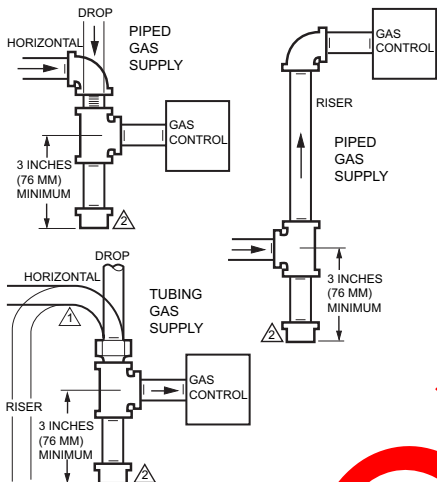

- ⚠ ALL BENDS IN METALLIC TUBING SHOULD BE SMOOTH.
- ⚠ CAUTION: SHUT OFF THE MAIN GAS SUPPLY BEFORE REMOVING END CAP TO PREVENT GAS FROM FILLING THE WORK AREA. TEST FOR GAS LEAKAGE WHEN INSTALLATION IS COMPLETE.

Fig. 2. Sediment trap installation.

Install Valve

1. Mount valve 90° to pipes, in any direction—including vertically—from the upright position of the gas control knob.
2. Mount the valve so gas flows in the direction of the arrow on the side of the valve.
3. Insert pipe 1/8 to 1/4 in. into the valve. Do not insert deeper than 3/8 in. Valve distortion or malfunction can result if the pipe is inserted too deeply.
4. Apply a moderate amount of good quality pipe compound (do not use Teflon tape) to pipe only, leaving two end threads bare. On LP installations, use compound resistant to LP gas. See Fig. 3.
5. Remove seals over valve inlet and outlet, if necessary.
6. Connect pipe to valve inlet and outlet. Use wrench on the other side of the pipe outlet. Refer to Fig. 4 through 6.

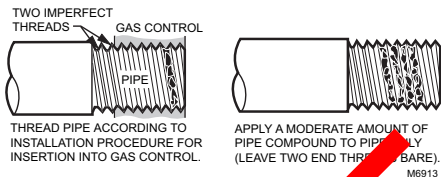

Fig. 3. Use moderate amount of pipe compound

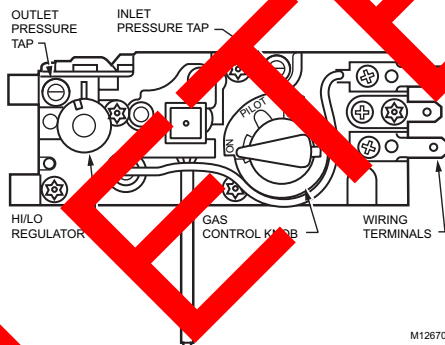

Fig. 4. Top view of gas valve with HI/LO regulator.

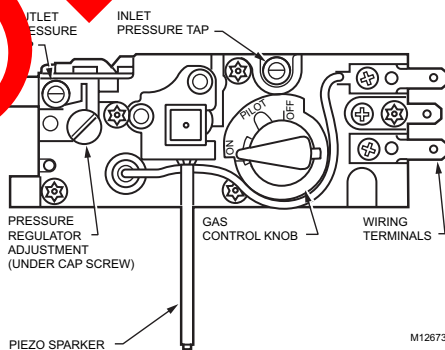

Fig. 5. Top view of gas valve with standard regulator.

WIRING

Follow the wiring instructions furnished by the appliance manufacturer, if available, or use the general instructions provided below. Where these instructions differ from the appliance manufacturer, follow the appliance manufacturer instructions. For a typical wiring diagram, see Fig. 7.

All wiring must comply with applicable electrical codes and ordinances.

Disconnect power supply before making wiring connections to prevent electrical shock or equipment damage.

1. Check the power supply rating on the gas valve and make sure it matches the available supply. Install the transformer, thermostat, and other controls, as required.
2. This valve can be used only in a self-generating system.

3. Adjust the thermostat heat anticipator to the 0.1A at 750 mV rating stamped on the valve operator.

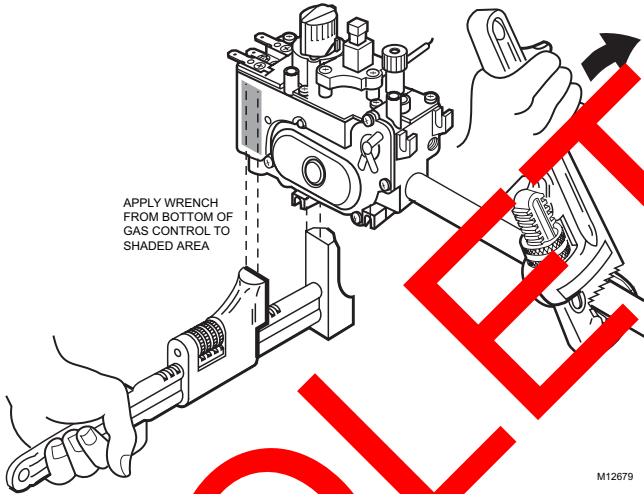

Fig. 6. Proper use of wrench on gas valve.



OPERATION

The Millivolt Gas Valve System includes a gas valve, quick drop-out thermocouple, thermopile, millivolt thermostat and a pilot burner. In this configuration, the thermopile drives the operator and the quick dropout thermocouple operates the power unit. See Fig. 7.

As an option, a piezo can be mounted on the valve to ignite the pilot burner. The piezo creates a spark when the plunger is depressed. The connecting wires of the piezo include a terminal to connect to the electrode of the pilot burner. The piezo is replaceable.

Pilot Gas Lighting Procedure

Lighting Standard Pilot (Without Piezo)

1. Turn the knob counterclockwise  to the PILOT position, push the knob down, and hold in position. The pilot valve opens and allows gas to flow to the pilot burner.
2. Light the pilot burner while holding down the knob until a strong flame is present (approximately 60 seconds).
3. Release the knob. The shaft will move upward and engage the safety valve lever that opens the safety valve.
4. Turn the knob counterclockwise  to the ON position. On a call-for-heat, the main valve opens and the main burner ignites.

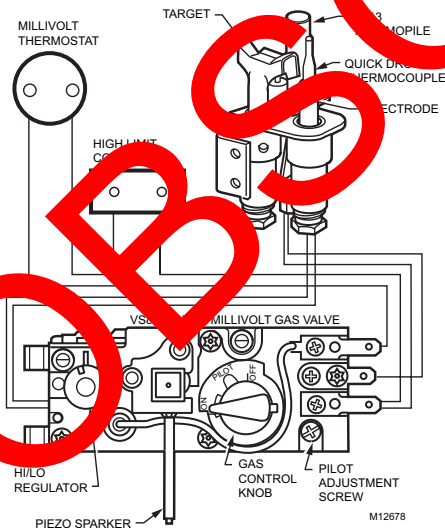





Fig. 7. Millivolt wiring system wiring diagram with quick drop-out thermocouple (VS8420D).

Lighting Pilot with Piezo

1. Turn the knob counterclockwise  to the PILOT position, push the knob down, and hold in position. The pilot valve opens and allows gas to flow to the pilot burner.
2. Push the plunger on the piezo until the pilot burner is lit. Hold down the knob until a strong flame is present (approximately 60 seconds).
3. Release the knob. The shaft will move upward and engage the safety valve lever that opens the safety valve.
4. Turn the knob counterclockwise  to the ON position. On a call-for-heat, the main valve opens and the main burner ignites.

Shut off Procedure

1. To shut off the system, turn the knob clockwise  to the OFF position. This action closes the main gas and safety valves; however, the power unit must drop out before the lighting sequence can begin again. The VS8420 drops out within 30 seconds.
2. To relight the pilot light, follow the steps in the Pilot Gas and Lighting Procedure section.

HI/LO Regulator

As you turn the HI/LO knob, the gas pressure changes.



1. Turn the knob clockwise  toward the HI setting to increase gas pressure.
2. Turn the knob counterclockwise  toward the LO setting to decrease gas pressure.

Table 1. HI/LO and Standard Regulator pressures in in. wc (kPa).

Type of Gas	HI/LO Regulator Setting Ranges		Standard Regulator
	HI	LO	
Natural	3.0 to 3.5	12 to 2.5	3.0 to 5.0
LP	9.0 to 11.0	3.7 to 6.5	8.0 to 12.0

CHECKOUT

WARNING



Fire or Explosion Hazard.
 Can cause property damage, severe injury or death.
 Do not force the gas control knob on the appliance. Use only your hand to turn the gas control knob. If the knob does not operate by hand, the valve should be replaced by a qualified service technician.

Control Knob Settings

- Gas control knob settings are as follows:
- OFF: Prevents main gas flow through the valve.
 - ON: Permits main burner and pilot gas flow. Gas valve and thermostat control main burner gas flow.
 - PILOT: Opens pilot valve and allows gas flow to the pilot burner.
 - HI/LO: Manually adjusts outlet pressure.

Minimum and maximum regulator settings vary for each individual gas valve. Table 1 lists possible minimums and maximums for gas valves. See gas valve label for actual minimum and maximum ranges.

Standard Pressure Regulator

1. Check the manifold pressure listed on the appliance nameplate. Gas valve outlet pressure should match the nameplate.
2. With the main burner operating, check the gas valve flow rate using the meter closing method or measure the pressure by attaching a pressure tube with a 1/4 in. shell ID to a manometer by connecting the manometer to the outlet pressure tap on the gas valve. See Figure 1.
3. If necessary, adjust the pressure regulator to match the appliance rating. See Table 1 for factory-set nominal inlet pressure and adjustment range.
 - a. Remove the pressure regulator adjustment cap screw.
 - b. Using a screwdriver, turn the inner adjustment screw clockwise  to increase or counterclockwise  to decrease gas pressure to the desired range.
 - c. Always replace the cap screw and tighten firmly to prevent gas leakage.
4. If desired outlet pressure or flow rate cannot be achieved by adjusting the gas valve, check the gas valve inlet pressure using a manometer at the gas valve inlet pressure tap. If inlet pressure is in the normal range (see Table 1), replace the gas valve; otherwise, take the necessary steps to provide proper gas pressure on the valve.

NOTE: Valves are shipped with the gas control knob in the ON position.

Perform Gas Leak Test

WARNING

Fire or Explosion Hazard.
 Can cause property damage, severe injury or death.
 Stand away from the main burner while lighting. Hidden gas leaks can cause flashbacks in the appliance vestibule. Check for gas leaks with rich soap and water solution any time work is done on a gas system.

Gas Leak Test

1. Paint the pipe connections upstream of the gas valve with a rich soap and water solution. Bubbles indicate a gas leak.
2. If a leak is detected, tighten the pipe connections.
3. Light the main burner.

4. With the main burner in operation, paint the pipe joints (including adapters) and valve inlet and outlet with a rich soap and water solution.
5. If another leak is detected, tighten the adapter screws, joints, and pipe connections.
6. Replace the part if the leak cannot be stopped.

Turn on System

Rotate the gas control knob counterclockwise  to ON.

Turn on Main Burner

Follow the instructions provided by the appliance manufacturer or turn up the thermostat to call for heat.

Check and Adjust Gas Input and Burner Ignition

IMPORTANT

Do not exceed the input rating stamped on the appliance nameplate, or the manufacturer recommended burner orifice pressure for size orifice(s) used.

IMPORTANT

For complete combustion, be sure the primary air supply to the main burner is adjusted properly. Follow the instructions of the appliance manufacturer.

Checking Gas Input By Clocking Gas Meter

1. Be sure there is no gas flow through the meter except to the appliance being checked.

NOTE: Other appliances must remain off with pilots extinguished, or the consumption must be deducted from the meter reading.

2. Convert the flow rate (as described in the Gas Controls Handbook, Form 70-2602).
3. Compare the Btu/h input rating on the appliance nameplate.

Checking Gas Input with Manometer

NOTE: Both the inlet and outlet pressure taps have a captive screw.

1. Be sure the gas control knob is in the OFF position.
2. Loosen, but do not remove the outlet tap captive screw.
3. Attach plastic tube with a 1/4 in. shell ID and connect to manometer.
4. Check the outlet tap pressure.
5. Turn the gas control knob to the OFF position.
6. Shut off the gas supply at the manual valve in the gas piping to the appliance or, for LP, at the tank.
7. Loosen, but do not remove the inlet tap captive screw.
8. Attach a plastic tube with a 1/4 in. shell ID and connect the manometer.
9. Check the inlet tap pressure.
10. Turn the gas control knob to the OFF position.
11. Repeat the Gas Leak Test at the pressure tap with the main burner operating.

Check Safety Shutdown Performance

WARNING

Fire or Explosion Hazard.
Can cause property damage, severe injury or death.
 Perform the safety shutdown test any time work is done on a gas system.

1. Place gas control knob in PILOT position. Main burner should go off and pilot should remain lit.
2. Extinguish pilot flame. The VS8410 pilot gas flow should stop within three minutes; the VS8420 pilot gas flow stops within three seconds. Pilot gas safety shutoff proves complete shutdown because the safety shutoff valve prohibits main burner pilot gas flow.
3. Relight pilot burner and operate the system through one complete cycle to ensure all controls operate properly.

MAINTENANCE

WARNING

Fire or Explosion Hazard.
Can cause property damage, severe injury or death.
 Do not attempt to take apart the gas valve or clean. Improper assembly and cleaning can result in unreliable operation.

Regular preventive maintenance is important in applications that place a heavy load on system controls such as those used in the commercial cooking and agricultural and industrial industries because:

- In applications such as commercial cooking, the equipment operates 100,000 to 200,000 cycles per year. This heavy cycling can wear out the gas valve in one to two years.
- Exposure to water, dirt, chemicals and heat can damage the gas valve and shut down the control system.

 The maintenance program should include regular system checkout as outlined in the Checkout section, and checkout of the control system as described in the appliance manufacturer literature.

Maintenance frequency must be determined individually for each application:

- Cycling frequency—Appliances that cycle 20,000 times annually should be checked monthly.
- Intermittent use—Appliances that are used seasonally should be checked before shutdown and again before the next use.
- Consequence of unexpected shutdown—Where the cost of an unexpected shutdown would be high, the system should be checked more often.
- Dusty, wet, or corrosive environment—Because these environments can cause the gas valve to deteriorate more rapidly, the system should be checked more often.

 Any valve should be replaced if it does not perform properly on checkout or service. In addition, replace any module if it is wet or looks like it has ever been wet.

SERVICE

⚠️ WARNING

Fire or Explosion Hazard
Attempted disassembly or repair can cause property damage, severe injury or death.
 Do not disassemble the gas valve; it contains no replaceable components.

⚠️ CAUTION

Equipment Damage.
Can burn out heat anticipator in thermostat.
 Do not apply a jumper across (or short) the valve coil terminals even temporarily.

If Main Burner Does Not Come On With Call For Heat

1. Confirm that the gas control knob is in the ON position.
2. Adjust the thermostat several degrees above the room temperature.
3. Use a dc voltmeter to measure the voltage across the THTP and TP terminals.
4. If no voltage is present, check the control circuit for proper operation.
5. If proper control system voltage is present, replace the gas valve.

WARNING TO THE APPLIANCE OWNER.

For Your Safety, Read the Pre-Lighting Appliance.

⚠️ WARNING

Fire or Explosion Hazard.
Can cause property damage, severe injury or death.
 Strictly follow the instructions for Pre-Lighting Checks.

Pre-Lighting Checks

1. Before lighting, smell around the appliance area for gas. If the appliance uses LP gas, be sure to smell next to the floor because LP gas is heavier than air.
2. If you smell gas, immediately shut off the manual valve in the gas piping to the appliance or, on LP, at the tank. Leave the building immediately and call your gas supplier. If your gas supplier cannot be reached, call the fire department.
3. Do not force the gas valve control knob. Use only your hand to turn the control knob.
4. If the knob does not operate by hand, the valve should be replaced by a qualified service technician.
5. The gas valve must be replaced if it was flooded with water. Call a qualified service technician.
6. The gas valve is a safety device. It must be replaced in the event of any physical damage such as bent terminals, missing or broken parts, stripped threads, or evidence of exposure to heat.

IMPORTANT

Follow the operating instructions provided by the manufacturer of your heating appliance.

TROUBLESHOOTING GUIDE

⚠️ WARNING

Fire or Explosion Hazard.
Can cause property damage, severe injury or death.
 Only a qualified service technician should perform these troubleshooting procedures.

Use Fig. 8 and Table 2 as a troubleshooting guide for the VS8420.

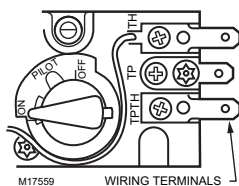

Fig. 8. Identification of VS8420 terminals for troubleshooting.

Table 2. VS8420 Troubleshooting Table.

Test	Test Title	Connect Multimeter Between Terminals	Set Thermostat	Meter Reading Should Be
A	Coil Resistance	TP and TH	Open	Maximum of 3.6 ohms.
B	Thermopile	TP and TPTH	Open	Minimum of 460 mV.
C	Thermocouple	Tip	Open	Minimum of 18 mV.
D	Operator Pull-In	TH and TP	Open	Minimum of 155 mV.
E	Resistance System	—	Closed	Maximum of 1.7 Ohms.

1. Coil Resistance: Have thermostat contacts open and Pilotstat knob turned to OFF. If coil resistance exceeds 3.6 ohms, replace valve.
2. Thermopile: Have thermostat contacts open and the pilot lit with Pilotstat knob turned to PILOT. If reading is less than 460 mV, replace thermopile.

3. Thermocouple: Have thermostat contacts open and pilot lit with the Pilotstat knob turned to PILOT. Reading should be a minimum of 18 mV for a new thermocouple. If the reading is less than 18 mV, replace thermocouple. Power unit will hold in down to 3 mV. If the output of the thermocouple is below 3 mV, replace it.
4. Operator Pull-in: Have thermostat contacts open and pilot lit with Pilotstat knob turned to PILOT. Close thermostat contacts. Operator will pull in with a minimum of 155 mV. Operator makes audible sound during pull-in. If pull-in does not occur, replace the valve.
5. Resistance System: System resistance from the remote switch or thermostat and leadwires should not exceed 1.7 ohms. If resistance is above 1.7 ohms, reduce the resistance.

OBSELETE

Honeywell

Home and Building Control
Honeywell Inc.
Honeywell Plaza
P.O. Box 524
Minneapolis, MN 55408-0524

Home and Building Control
Honeywell Limited-Honeywell Limitée
155 Gordon Baker Road
North York, Ontario
M2H 3N7

