

# Honeywell

# Installation Guide

This is a legacy product document supported by Resideo. It is no longer manufactured.

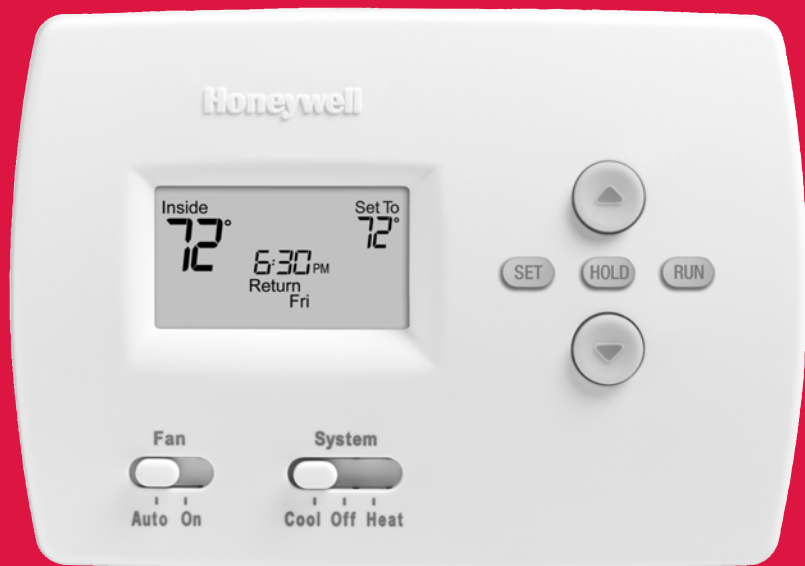

## PRO TH4110D

Programmable Thermostat



69-1849

## Product Application

This thermostat provides electronic control of 24 VAC single-stage heating and cooling systems, or 750 mV heating systems.

### System Types

- Gas, oil, or electric heat with air conditioning
- Warm air, hot water, high-efficiency furnaces, heat pumps, steam, gravity
- Heat only
- Heat only with fan
- Cool only
- 750 mV heating systems

### Power Type

- Battery power
- Common wire
- Common wire with battery backup

### System Settings

- Heat, Off, Cool

### Fan Settings

- Auto, On

## Must be installed by a trained, experienced technician

- Read these instructions carefully. Failure to follow these instructions can damage the product or cause a hazardous condition.
- Check the ratings in this booklet to verify that this product is suitable for your application (see page 13).
- Always test for proper operation after installation (see pages 8-9).



#### **CAUTION: ELECTRICAL HAZARD**

Can cause electrical shock or equipment damage. Disconnect power before beginning installation.



#### **MERCURY NOTICE**

If this product is replacing a control that contains mercury in a sealed tube, do not place the old control in the trash. Contact your local waste management authority for instructions regarding recycling and proper disposal.

# Table of contents

## Installation

Pre-installation checklist .....2  
Wallplate installation .....3  
Wiring.....4  
Wiring diagrams .....5

## Installer Setup

Fan operation settings .....6  
Battery installation .....7  
Thermostat mounting .....7  
Installer setup.....8  
Installer system test .....8

## Appendices

Adaptive Intelligent Recovery .....10  
Compressor protection .....10  
Quick reference to controls.....11  
Quick reference to display.....11  
In case of difficulty .....12  
Accessories.....13  
Specifications .....13

# Installation tips

Install the thermostat about 5 feet (1.5m) above the floor in an area with good air circulation at average temperature.

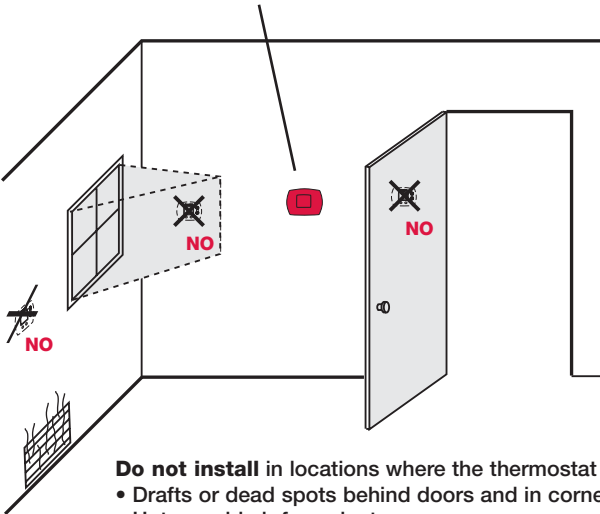

**Do not install** in locations where the thermostat can be affected by:

- Drafts or dead spots behind doors and in corners
- Hot or cold air from ducts
- Sunlight or radiant heat from appliances
- Concealed pipes or chimneys
- Unheated/uncooled areas such as an outside wall behind the thermostat

## Pre-installation checklist

### Package contents

Check to make sure your package includes the following items:

- PRO TH4110D digital thermostat (wallplate attached to back)
- Operating manual
- Wall anchors and mounting screws (2 each)
- AA alkaline batteries (2)
- Quick reference card

### Required tools & supplies

- No. 2 Phillips screwdriver
- Small pocket screwdriver
- Drill
- Drill bit (3/16" for drywall, 7/32" for plaster)
- Hammer
- Pencil
- Electrical tape
- Level (optional)

## Wallplate installation

Grasp top and bottom of wallplate and pull to remove from thermostat.

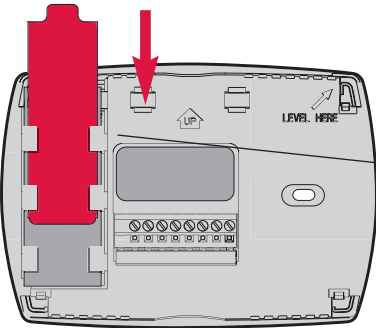
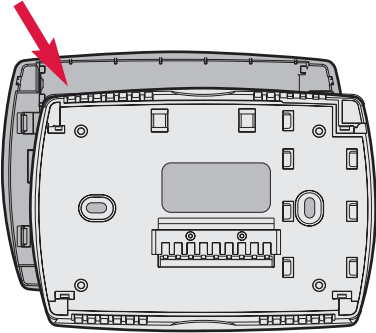

Remove the wallplate from the thermostat as shown at left, then follow directions below for mounting.

- 1 Pull wires through wire hole.
- 2 Position wallplate on wall, level and mark hole positions with pencil.
- 3 Drill holes at marked positions as shown below, then tap in supplied wall anchors.
- 4 Place wallplate over anchors, insert and tighten mounting screws.
- 5 Insert quick reference card in slot in front of wall plate.

Insert quick reference card after wallplate is mounted (see mounting instructions, below)

Drill 3/16" holes for drywall.  
Drill 7/32" holes for plaster.

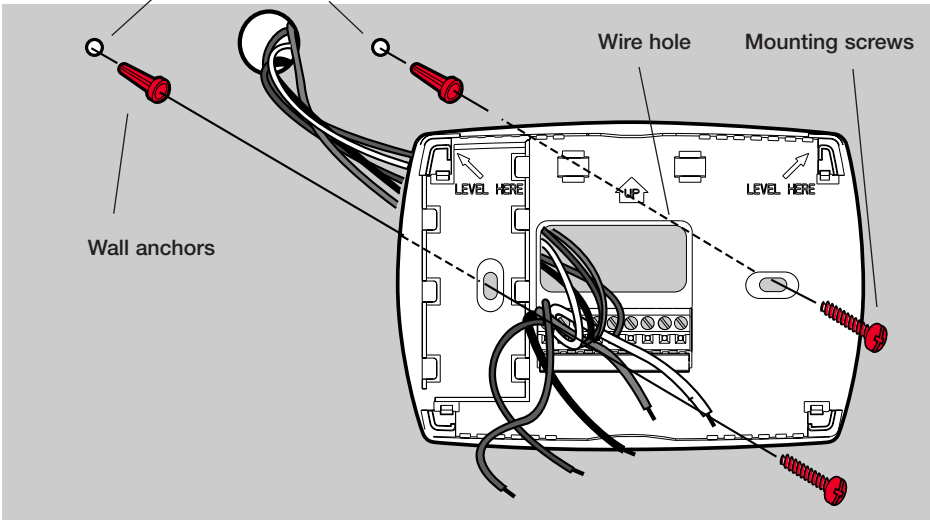

## Wiring



**CAUTION: ELECTRICAL HAZARD.** Can cause electrical shock or equipment damage. Disconnect power before wiring.

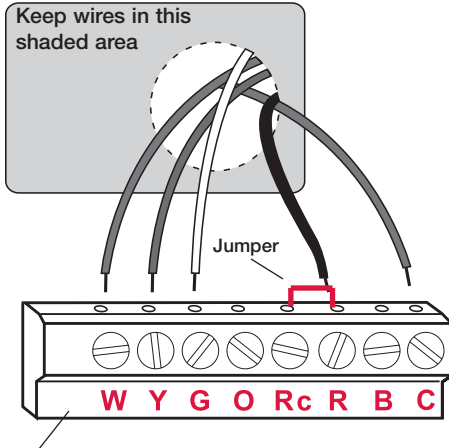

Terminal block

### NOTES

#### R & Rc terminals

In single-transformer system, leave metal jumper in place between R & Rc. Remove metal jumper if two-transformer system.

#### Heat pump systems

If wiring to a heat pump, use a small piece of wire (not supplied) to connect terminals **W** and **Y**.

#### C terminal

The C (common wire) terminal is optional when thermostat is powered by batteries.

#### Wire specifications

Use 18- to 22-gauge thermostat wire. Shielded cable is not required.

## Wiring

- 1 Loosen screw terminals, insert wires into terminal block, then re-tighten screws.
- 2 Push excess wire back into the wall opening. Keep wires in shaded area as shown at left.
- 3 Plug the wall opening with non-flammable insulation to prevent drafts from affecting thermostat operation.

## Terminal Designations

**W** Heat relay.

**Y** Compressor contactor.

**G** Fan relay.

**O** Heat pump changeover valve energized in cooling.

**Rc** Cooling power. Connect to secondary side of cooling system transformer.

**R** Heating power. Connect to secondary side of heating system transformer.

**B** Heat pump changeover valve energized in heating.

**C** Common wire from secondary side of cooling system transformer.

## Wiring diagrams

- 1** Power supply. Provide disconnect means and overload protection as required.
- 2** Factory-installed jumper. Remove for 2-transformer systems only.
- 3** Use either **O** or **B** terminals for changeover valve.
- 4** Use a small piece of wire (not supplied) to connect **W** and **Y** terminals.
- 5** Set fan operation switch to **Heat Pump** (see page 6) and configure for heat pump (see pg. 8).
- 6** Optional 24 VAC common connection.

**Typical 1H/1C system: 1 transformer**

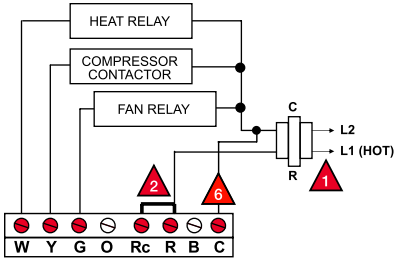

**Typical 1H/1C system: 2 transformers**

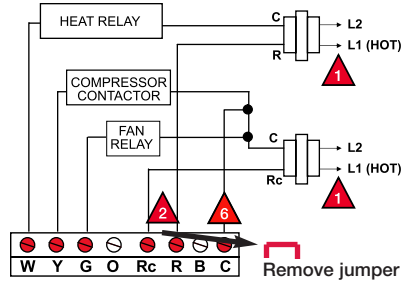

**Typical 1H/1C heat pump system**

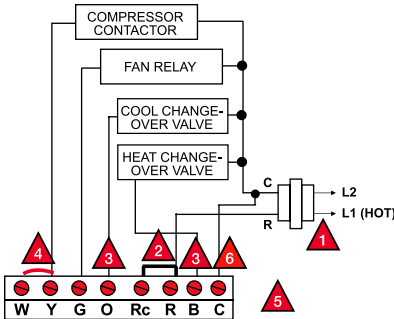

**Typical heat-only system**

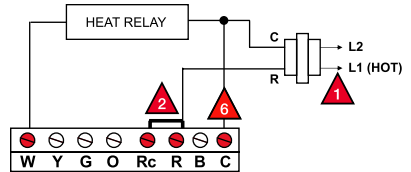

**Typical heat-only system with fan**

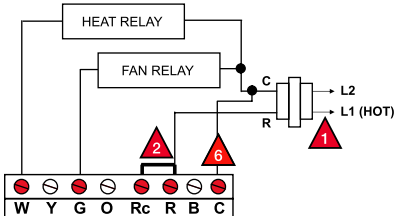

**Typical cool-only system**

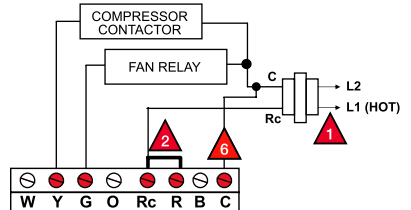

## Fan operation settings

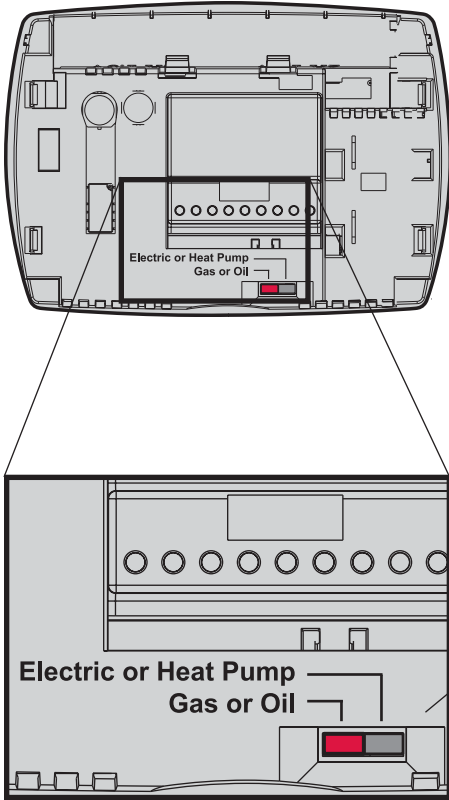

- **Gas or Oil:** For gas or oil heating systems, leave the fan operation switch in this factory-set position (This setting is for systems that control the fan in a call for heat.)
- **Electric or Heat Pump:** Change the switch to this setting for heat pump or electric heat systems. (This setting is for systems that allow the thermostat to control the fan in a call for heat, if a fan wire is connected to the **G** terminal.)



## Power options & mounting

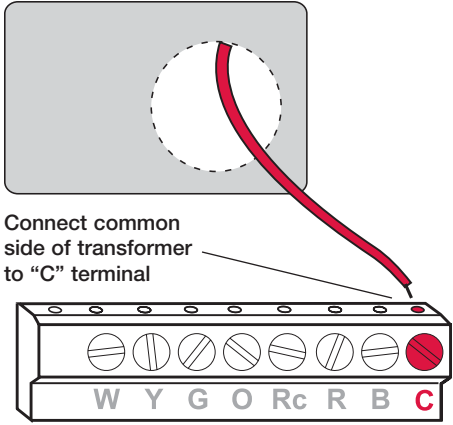

### AC Power

The thermostat can be powered by 24 VAC power, or by batteries.

To wire the thermostat for AC power, connect the common side of the cooling transformer to the "C" terminal as shown at left.

**Important:** Remove R/R<sub>c</sub> jumper for 2-transformer systems only. (See wiring diagram on page 5.)

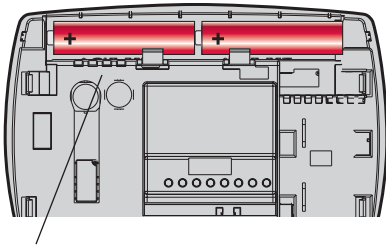

Install batteries in back of thermostat (optional if AC powered).

### Battery Power

The thermostat can be powered by batteries alone or, if used with AC power, can provide backup power. During power interruptions the batteries will save time/day settings and power the display.

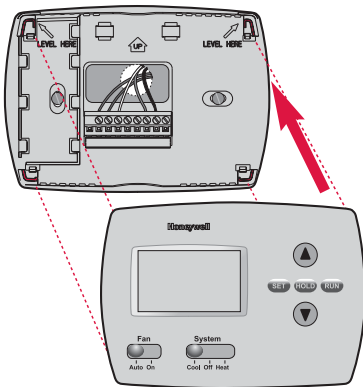

### To Mount Thermostat

Align the 4 tabs on the wallplate with corresponding slots on the back of the thermostat, then push gently until the thermostat snaps in place.

## Installer setup

Follow the procedure below to configure the thermostat to match the installed heating/cooling system, and customize feature operation as desired.

Press and hold both buttons

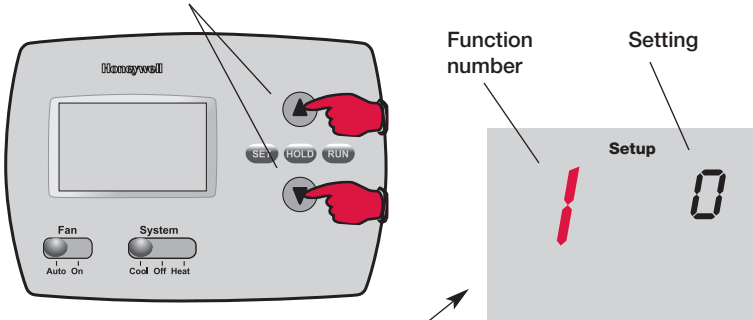

To begin, press and hold the ▲ and ▼ buttons until the display changes

Press ▼ to change settings

Press ▲ to advance to next function

Press and hold ▼▲ to exit and save settings

### Setup Function

- 1 System type**
- 5 Heating cycle rate**  
(CPH: cycles/hour)
- 9 Compressor cycle rate** (CPH)
- 13 Adaptive Intelligent Recovery**
- 14 Temperature display**
- 15 Compressor protection**

### Settings & Options

- 0 Gas, oil or electric heat with air conditioning**
  - 1 Heat pump (5 minute compressor off time in heating and cooling)
- 5 For gas or oil furnaces of less than 90% efficiency**
  - 1 For steam or gravity systems
  - 3 For hot water systems & furnaces of over 90% efficiency
  - 9 For electric furnaces
  - [Other cycle rate options: 2, 4, 6, 7, 8, 10, 11 or 12 CPH]
- 3 Recommended for most compressors**
  - [Other cycle rate options: 1, 2, 4, 5 or 6 CPH]
- 1 On \*\*See page 10**
- 0 Off**
- 0 Fahrenheit**
- 1 Celsius**
- 5 Five-minute compressor off time \*\*See page 10**
  - [Other options: 0, 1, 2, 3 or 4-minute off time]

## Installer system test

After completing the installer setup above, press the ▲ button again to begin a system test (see next page).

## Installer system test

Follow the procedure below to test the heating and cooling system.

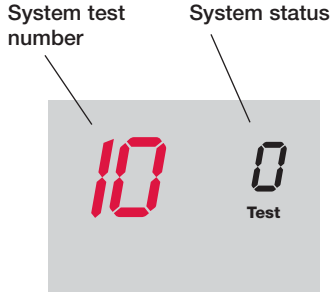
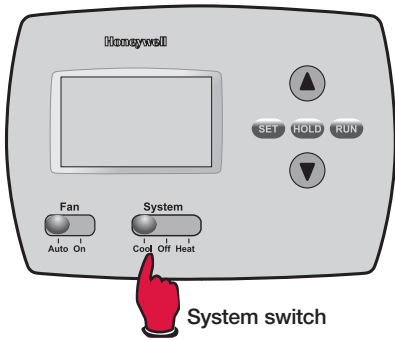

- 1 Set **SYSTEM** switch to Cool.
- 2 Press ▼ to turn on cooling system, then check system status (see table, below).
- 3 Press ▼ to turn off cooling system.
- 4 Set **SYSTEM** switch to Heat.
- 5 Press ▼ to turn on heating system, then check system status (see table, below).
- 6 Press ▼ to turn off heating system.
- 7 [Optional] Set **SYSTEM** switch to Off to display thermostat information (see table, below). Press ▼ to display 71-76.
- 8 Press and hold ▼ ▲ to terminate system test at any time.

### System Test

### System Status

<b>10 Heating system</b>	0 Heat and fan turn off. 1 Heat turns on. Fan also turns on immediately if Fan Operation Switch is set to <u>Electric Heat/Heat Pump</u> (see page 6).
<b>30 Cooling system</b>	0 Compressor and fan turn off. 1 Compressor and fan turn on.
<b>70 Thermostat information</b> (for reference only)	71 Software revision number (major revisions) 72 Software revision number (minor revisions) 73 Configuration identification code (major) 74 Configuration identification code (minor) 75 Production configuration date code (week) 76 Production configuration date code (year)



#### **CAUTION: EQUIPMENT DAMAGE HAZARD**

Compressor protection (minimum off time) is bypassed during testing. To prevent equipment damage, avoid cycling the compressor quickly.

## Adaptive Intelligent Recovery™ (Setup Function 13)

Adaptive Intelligent Recovery eliminates guesswork when setting your schedule. It allows the thermostat to “learn” how long your furnace and air conditioner take to reach the temperature you want.

Just set your program schedule to the time you want the house to reach your desired temperature. The thermostat then turns on the heating or cooling at just the right time to reach your scheduled temperature at your scheduled time.

For example: Set the Wake time to 6 am, and the temperature to 70°. The heat will come on before 6 am, so the temperature is 70° by the time you wake at 6.

## Built-in compressor protection (Setup Function 15)

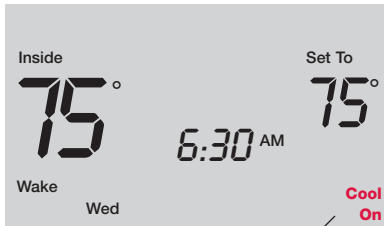

Message flashes until safe restart time has elapsed

This feature helps prevent damage to the compressor in the air conditioning or heat pump system.

Damage can occur if the compressor is restarted too soon after shutdown. This feature forces the compressor to wait for a few minutes before restarting.

During the wait time, the message Cool On (or Heat On if you have a heat pump) will flash on the display. When the safe wait time has elapsed, the message stops flashing and the compressor turns on.

## Quick reference to controls

### Temperature adjustment

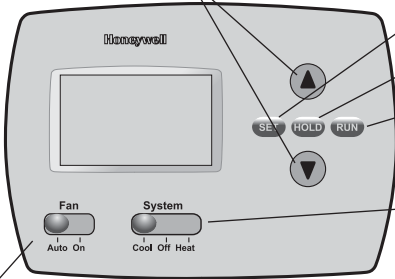

- **Set:** Press to set time/day/schedule
- **Hold:** Press to override programmed temperature control.
- **Run:** Press to resume program schedule

### Fan switch

**On:** Fan runs continuously.  
**Auto:** Fan runs only when heating or cooling system is on.

### System switch

- **Cool:** Thermostat controls only the cooling system.
- **Heat:** Thermostat controls only the heating system.
- **Off:** Heating and cooling systems are off.

## Quick reference to display screen

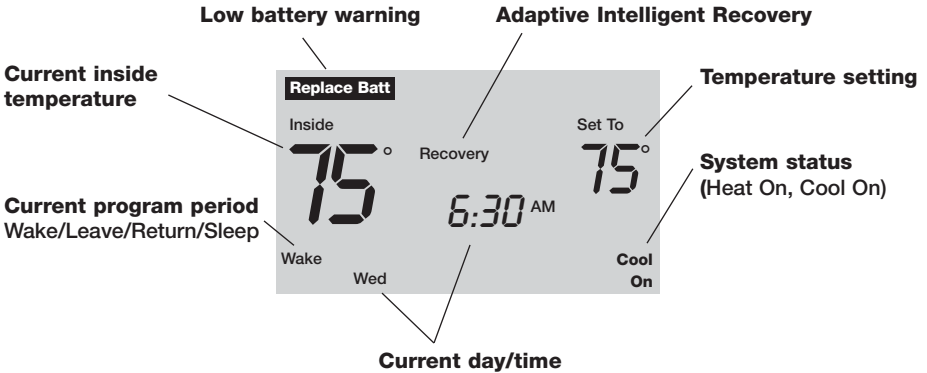

## In case of difficulty

If you have difficulty with your thermostat, please try the suggestions below. Most problems can be corrected quickly and easily.

- Display is blank**
- Check circuit breaker and reset if necessary.
  - Make sure heating & cooling power switches are on.
  - Make sure equipment door is securely closed.
  - If battery powered, make sure fresh AA alkaline batteries are installed.
- Temperature settings do not change**
- Make sure heating and cooling temperatures are set to acceptable ranges:
- Heat: 40° to 90°F (4.5° to 32°C).
  - Cool: 50° to 99°F (10° to 37°C).
- Heating system does not respond (“Heat On” appears on screen)**
- Check for 24 Vac at the equipment on the secondary side of the transformer between power and common. If voltage is not present, check the heating equipment to find the cause of the problem.
  - Check for 24 Vac between the heat terminal (W) and the transformer common. If 24 Vac is present, the thermostat is functional. Check the heating equipment to find the cause of the problem.
  - Check for loose or broken wires between the thermostat and the heating equipment.
- Cooling system does not respond (“Cool On” appears on screen)**
- Check for 24 Vac at the equipment on the secondary side of the transformer between power and common. If voltage is not present, check the cooling equipment to find the cause of the problem.
  - Check for 24 Vac between the cooling terminal (Y) and the transformer common. If 24 Vac is present, the thermostat is functional. Check the cooling system to find the cause of the problem.
  - Check for loose or broken wires between the thermostat and the cooling equipment.
- Fan does not turn on in a call for heat**
- Make sure the Fan Operation switch is set to the proper system.
- “Cool On” or “Heat On” is flashing**
- Compressor protection timeout is engaged. Wait 5 minutes for the system to restart safely, without damage to the compressor.
- “Heat On” is not displayed**
- Set the System switch to Heat, and set the temperature level above the current room temperature.
- “Cool On” is not displayed**
- Set the System switch to Cool, and set the temperature level below the current room temperature.

## Accessories

Please contact your distributor to order accessories.

Cover plate assembly .....Part Number 50002883-001  
(Used to cover marks left by old thermostats.)

## Specifications

### Temperature Ranges

- Heat: 40° to 90°F (4.5° to 32°C)
- Cool: 50° to 99°F (10° to 37°C)

### Operating Ambient Temperature

- 32° to 120°F (0° to 48.9°C)

### Shipping Temperature

- -20° to 120°F (-28.9° to 48.9°C)

### Operating Relative Humidity

- 5% to 90% (non-condensing)

### Physical Dimensions

- 3-13/16" H x 5-3/8" W x 1-1/4" D
- 97 mm H x 137 mm W x 32 mm D

### Electrical Ratings

System	Voltage (50/60Hz)	Running Current
Heating	20-30 Vac	0.02-1.0 A
(Powerpile)	750 mV DC	100 mA DC
Cooling	20-30 Vac	0.02-1.0 A

## **Automation and Control Solutions**

Honeywell International Inc.

1985 Douglas Drive North

Golden Valley, MN 55422

<http://yourhome.honeywell.com>

Honeywell Limited-Honeywell Limitée

35 Dynamic Drive

Scarborough, Ontario M1V 4Z9



Printed in U.S.A. on recycled paper containing at least 10% post-consumer paper fibers.

© U.S. Registered Trademark.  
© 2005 Honeywell International Inc.  
Patents pending. All rights reserved.  
69-1849 • 06-2005

# **Honeywell**