



V400 AND V800 COMBINATION GAS CONTROLS

INSTALLATION INSTRUCTIONS

APPLICATION

V400 and V800 are used on gas fired standing pilot appliances with 30 mV thermocouple. These gas controls include a manual gas valve, safety shutoff, single millivoltage automatic operator, and pressure regulator, pilot gas filter and flow adjustment, pressure tapping, and thermocouple connector.

V400 is used on 120V systems. V800 is used on 24V systems. Refer to Table 1 for more specifications. Refer to Table 2 for available gas capacities.

V800 gas controls are available with 1/4 x 1/4 inch or 3/16 x 1/4 inch energy cut-off (ECO) quick-connects. With the connector, an ECO high limit can be connected into the power circuit. When the temperature at the ECO exceeds the high limit, a switch opens and de-energizes

the power unit and shuts off main burner and pilot gas flow. To restart system, pilot flame must be relit and gas control must be reset manually.

Power for the gas control and the control system is provided by a 30 mV thermocouple. We recommend the Q340 Thermocouple.

Replacement parts:

1. Energy cut off (ECO) connector: 392451-1
2. Pressure Regulators:
 - Standard opening pressure regulator: V5306A,B.
 - Step opening pressure regulator: V5307A,B.
3. Valve Operators:
 - Line Voltage Operator: V404B.
 - Low Voltage Operator: V804B.

Table 1. Model Specifications.

Model Number Suffix Letter	Ambient Temperature Range	Pressure Regulator Type	Pressure Regulator Model
A	32° F to 175° F [0° C to 79° C]	Standard-Opening	V5306A
C	32° F to 175° F [0° C to 79° C]	Step-Opening	V5307A
M	-40° F to 175° F [-40° C to 79° C]	Standard-Opening	V5306B
P	-40° F to 175° F [-40° C to 79° C]	Step-Opening	V5307B

Table 2. Gas Control Capacities

Pipe Size (Inlet x Outlet)	Gas Control Capacity ^a At 1 Inch WCPD		Maximum Regulation Capacity		Minimum Regulation Capacity	
	ft ³ /hr	m ³ /hr	ft ³ /hr	m ³ /hr	ft ³ /hr	m ³ /hr
1/2" x 3/8"	110	3.1	110	3.1	11	0.3
1/2" x 1/2"	225	6.4	225	6.4	23	0.7
1/2" x 3/4"	250	7.1	290	8.2	23	0.7
3/4" x 3/4"	335	9.5	425	12.0	34	1.0

^a Capacity is based on 1000 Btu/ft³, 0.64 specific gravity natural gas at 1 inch wc pressure drop [37.3 MJ/m³, 0.64 specific gravity natural gas at 0.25 kPa pressure drop]. Use conversion factors to convert to other gases.

Type of Gas	Specific Gravity	Multiply Listed Capacity by:
Manufactured	0.60	0.516
Mixed	0.70	0.765
Propane	1.53	1.62



INSTALLATION

When Installing this Product...

1. Read these instructions carefully. Failure to follow them could damage the product or cause a hazardous condition.
2. Check the ratings given in these instructions and on the product to ensure the product is suitable for your application.
3. Ensure installer is a trained, experienced service technician.
4. After completing installation, use these instructions to check product operation.

⚠️ WARNING

**Fire or explosion hazard
Can cause property damage, severe injury, or death**
Follow these warnings exactly:

1. Disconnect power supply before wiring to prevent electrical shock or equipment damage.
2. To avoid dangerous accumulation of fuel gas, turn off gas supply at appliance service valve before starting installation and perform Gas Leak Test following installation.
3. Do not bend pilot gas tubing at control or at pilot burner after compression fitting is tightened. Gas leakage at the connection may result.
4. Always install sediment trap in gas supply line to prevent contamination of gas control.
5. Do not force gas control knob. Use only your hand to turn gas control knob. If the knob will not operate by hand, the control should be replaced by a qualified service technician. Force or attempted repair may result in fire or explosion.

⚠️ CAUTION

Never apply a jumper across (or short) gas control coil terminals. This may burn out thermostat heat anticipator.

IMPORTANT

These gas controls are shipped with protective seals over inlet and outlet tappings. Do not remove seals until ready to connect piping.

Follow the appliance manufacturer's instructions if available; otherwise, use the instructions provided below as a guide.

Choose Location

Do not locate the combination gas control where it may be affected by steam cleaning, high humidity, dripping water, corrosive chemicals, dust or grease accumulation, or excessive heat. To ensure proper operation, follow these guidelines.

- Locate in a well ventilated area.
- Mount high enough above the cabinet bottom to avoid exposure to flooding or splashing water.
- Ensure the ambient temperature does not exceed the ambient temperature ratings for each component.

- Cover gas control if appliance is cleaned with water, steam, or chemicals or to avoid dust and grease accumulation.
- Avoid locating where exposure to corrosive chemical fumes or dripping water are likely.

Mount combination gas control in the appliance vestibule on the gas manifold. In replacement applications, mount gas control in the same location as the old control.

Install Piping to Control

All piping must comply with local codes and ordinances or with National Fuel Gas Code (ANSI Z223.1 NFPA No. 54), whichever applies. Tubing installation must comply with approved standards and practices.

1. Use new, properly reamed pipe free from chips. If tubing is used, make sure ends are square, deburred, and clean. All tubing bends must be smooth and without deformation.
2. Run pipe or tubing to the control. If tubing is used, obtain a tube-to-pipe coupling to connect tubing to the control.
3. Install sediment trap in gas supply line. Refer to Fig. 1.

Install Control

1. This control can be mounted 0-90 degrees, in any direction, from the upright position of the gas control knob, including vertically.
2. Mount the control so gas flow is in direction of arrow on bottom of control.
3. Thread pipe the amount shown in Table 3 for insertion into control. **DO NOT THREAD PIPE TOO FAR.** Valve distortion or malfunction may result if pipe is inserted too deeply.

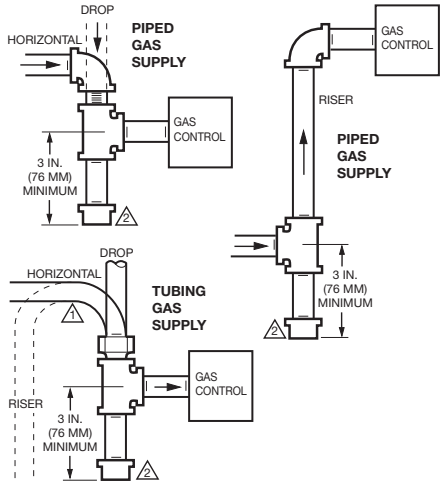

⚠️ ALL BENDS IN METALLIC TUBING SHOULD BE SMOOTH.

⚠️ CAUTION: SHUT OFF THE MAIN GAS SUPPLY BEFORE REMOVING END CAP TO PREVENT GAS FROM FILLING THE WORK AREA. TEST FOR GAS LEAKAGE WHEN INSTALLATION IS COMPLETE. M3077C

Fig. 1. Install sediment trap.

Table 3. NPT Pipe Thread Length (in.).

Pipe Size	Overall Thread Length	Maximum Depth Pipe Can Be Inserted Into Control
3/8	9/16	3/8
1/2	3/4	1/2
3/4	13/16	3/4
1	9/16	1

- Apply moderate amount of good quality pipe compound to adapter, leaving two end threads bare. Refer to Fig. 2. (On LP gas installations, use compound resistant to LP gas.) Do not use Teflon tape.
- Remove seals over control inlet and outlet, if necessary.
- Connect pipe to control inlet and outlet. To tighten inlet and outlet connections, use wrench on projecting wrench boss. Refer to Fig. 3 and 4.

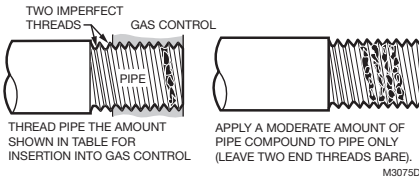

Fig. 2. Use moderate amount of pipe compound.

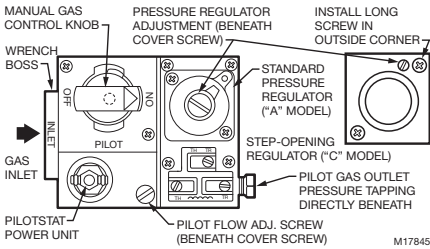

Fig. 3. Top view of standard capacity gas control.

Connect Pilot Gas Tubing

- Cut tubing to desired length and bend as necessary for routing to pilot burner. Do not make sharp bends or deform tubing. Do not bend tubing at control after compression nut has been tightened, as this may result in gas leakage at connection.
- Square off and remove burrs from end of tubing.
- Unscrew brass compression fitting from pilot gas outlet. Refer to Fig. 4. Slip fitting over tubing and slide out of way.

NOTE: When replacing a control, cut off old compression fitting and replace with new compression fitting provided on new combination gas control. Never use old compression fitting as it may not provide a gas-tight seal. Refer to Fig. 4.

- Push tubing into pilot gas tapping on outlet end of the control until it bottoms. While holding tubing all the way in, slide fitting into place and engage threads. Turn until finger tight. Then tighten one more turn with wrench. Do not overtighten.
- Connect other end of tubing to pilot burner according to pilot burner manufacturer's instructions.

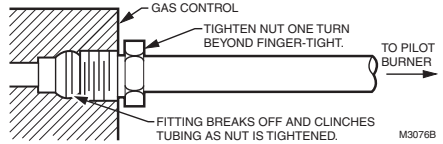

Fig. 4. Always use new compression fitting.

Connect Thermocouple

The thermocouple connection to the power unit or ECO connector (Fig. 3) is an electrical connection and must be clean and dry. Never use pipe compound. Tighten only 1/4 turn beyond finger tight to give good electrical continuity.

Connect ECO (Standard-Capacity models only)

If the ECO is provided, the leadwires must be equipped with insulated 1/4 in. female quick-connect terminals. Leadwire lengths must not exceed the lengths shown in Table 4 and 5. Connect high limit or ECO leadwires to the two terminals on the thermocouple.

If ECO is not provided, connect a Q313B Thermopile Generator in place of the thermocouple to act as the highlimit for the system.

Table 4. Maximum Length of Supplementary Limit Leadwires When Using Q340A Thermocouple.

Thermocouple Length		Maximum Leadwire Length x 2 (Wires)					
		AWG No. 14		AWG No. 16		AWG No. 18	
in.	m	in.	m	in.	m	in.	m
18	0.5	35	0.9	22	0.6	13	0.3
24	0.6	29	0.7	18	0.5	11	0.3
30	0.8	23	0.6	15	0.4	9	0.2
36	0.9	17	0.4	11	0.3	6	0.2
48	1.2	DO NOT USE.					
60	1.5						

Table 5. Maximum Length of Supplementary Limit Leadwire When Using Q309A Thermocouple.

Thermocouple Length		Maximum Leadwire Length x 2 (Wires)					
		AWG No. 14		AWG No. 16		AWG No. 18	
in.	m	in.	m	in.	m	in.	m
12	0.3	47	1.2	30	0.8	18	0.5
18	0.5	41	1.0	26	0.7	16	0.4
24	0.6	35	0.9	22	0.6	14	0.4
30	0.8	29	0.8	18	0.5	11	0.3
36	0.9	23	0.6	15	0.4	9	0.2
40	1.0	19	0.5	12	0.3	7	0.2
48	1.2	11	0.3	7	0.2		
60	1.5	DO NOT USE.					

WIRING

Follow appliance manufacturer's wiring instructions, if available, or use general instructions provided below.

All wiring must comply with applicable electrical codes and ordinances or with the National Electrical Code (ANSI/NFPA 70), whichever applies.

Disconnect power supply before making wiring connections to prevent electrical shock.

Wiring V400 models

1. Refer to Fig. 5 for typical wiring diagram.
2. Ensure power supply rating on each control matches the available supply.
3. Install line voltage thermostat (or controller) and other controls as required.
4. Use junction box, as shown, when connecting control circuit to gas control operator.
5. Make conduit connection to operator as follows:
 - a. Slip conduit fittings over integral leadwires and screw securely into hole in operator cover.
 - b. Cut flexible conduit to approximate length.
 - c. Slip conduit over leadwires and attach to fittings.
 - d. Route and connect both flexible conduits to junction box.

- e. Connect integral wires to control circuit. Do not splice except within a junction box.

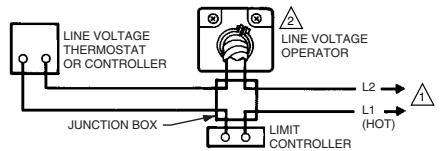

⚠️ POWER SUPPLY. PROVIDE DISCONNECT MEANS AND OVERLOAD PROTECTION AS REQUIRED.

⚠️ LINE VOLTAGE ENCLOSURE NOT PART OF GAS CONTROL. LINE VOLTAGE GAS CONTROLS MUST BE USED IN AN OEM APPROVED ENCLOSURE. M17846

Fig. 5. Typical V400 wiring diagram.

Wiring V800 models

1. Ensure the power supply rating on each control matches the available supply.
2. Install transformer, low voltage thermostat, and other controls as required.
3. Connect control circuit to operator terminals. Refer to Fig. 6 for a typical wiring diagram.
4. Adjust thermostat heat anticipator to 0.2A rating stamped on valve operator.

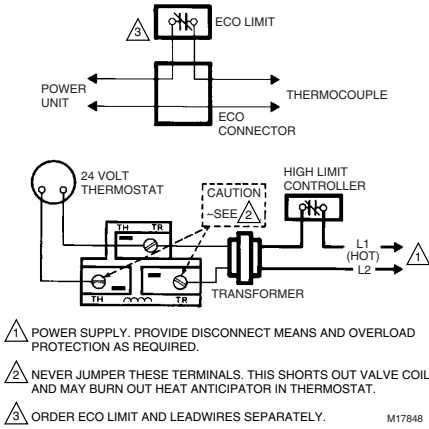





- ⚠ POWER SUPPLY. PROVIDE DISCONNECT MEANS AND OVERLOAD PROTECTION AS REQUIRED.
- ⚠ NEVER JUMPER THESE TERMINALS. THIS SHORTS OUT VALVE COIL AND MAY BURN OUT HEAT ANTICIPATOR IN THERMOSTAT.
- ⚠ ORDER ECO LIMIT AND LEADWIRES SEPARATELY. M17848

Fig. 6. Typical V800 wiring diagram.

Gas Leak Test

1. Paint pipe connections upstream of gas control with rich soap and water solution. Bubbles indicate gas leak.
2. If leak is detected, tighten pipe connections.
3. Stand clear while lighting main burner to prevent injury caused from hidden leaks which could cause flashback in the appliance vestibule. Light main burner.
4. With main burner in operation, paint pipe joints (including adapters) and control inlet and outlet with rich soap and water solution.
5. If another leak is detected, tighten adapter screws, joints, and pipe connections.
6. Replace part if leak can not be stopped.



Light Pilot

1. Turn gas control knob clockwise  to OFF. Wait five minutes to dissipate any unburned gas. Sniff around the appliance near the floor. Do not relight pilot flame if you smell gas.
2. Turn gas control knob counterclockwise  to PILOT. Push down and hold the knob while lighting the pilot flame.
3. Hold the gas control knob down about one minute, then release.
 - If pilot flame goes out, turn gas control knob clockwise  to OFF and repeat steps 1 through 3.
 - If pilot flame remains lit, turn gas control knob counterclockwise  to ON.

Adjust Pilot Flame

The pilot flame should envelop 3/8 to 1/2 in. [10 to 13 mm] of the thermocouple tip. Refer to Fig. 7.

To adjust pilot flame:

1. Remove pilot adjustment cover screw. Refer to Fig. 3.
2. Turn inner adjustment screws clockwise  to decrease or counterclockwise  to increase pilot flame.
3. Always replace cover screw after adjustment and tighten firmly to ensure proper operation.

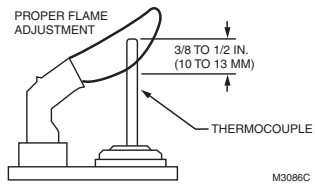

Fig. 7. Proper flame adjustment.

Turn On Main Burner

Follow appliance manufacturer instructions or adjust thermostat to call for heat.

STARTUP AND CHECKOUT

⚠ WARNING

Fire or Explosion Hazard
Can cause property damage, severe injury, or death

1. Do not force the gas control knob. Only use your hand to push down and turn gas control knob. Never use any tools.
2. If the gas control knob will not operate by hand, a new control should be installed by a qualified service technician.

Gas Control Knob Settings

Gas control knob settings are as follows:
OFF prevents pilot and main burner gas flow.
PILOT permits pilot gas flow only. Gas control knob must be held depressed or thermocouple must be heated sufficiently to hold the safety control valve open.
ON permits pilot or main burner gas flow under control of thermostat and ignition module.

Perform Gas Leak Test

⚠ WARNING



Fire or Explosion Hazard
Can cause property damage, severe injury, or death

Check for gas leaks with soap and water solution any time work is done on a gas control.



Check And Adjust Gas Input To Main Burner

CAUTION

- Do not exceed input rating stamped on appliance nameplate, or manufacturer's recommended burner orifice pressure for size orifice(s) used. Make certain primary air supply to main burner is properly adjusted for complete combustion. Follow appliance manufacturer instructions.
- IF CHECKING GAS INPUT BY CLOCKING GAS METER:
 - Ensure that the only gas flow through the meter is that of the appliance being tested.
 - Ensure other appliances are turned off and their pilot burners are extinguished (or deduct their gas consumption from the meter reading).
 - Convert flow rate to Btuh as described in the Gas Controls Handbook (form number 70-2602) and compare to Btuh input rating on appliance nameplate.
- IF CHECKING GAS INPUT WITH MANOMETER:
 - Ensure gas control knob is in PILOT position before removing outlet pressure tap plug to connect manometer (pressure gauge).
 - Turn gas control knob back to PILOT when removing gauge and replacing plug.
 - Shut off gas supply at the appliance service valve or, for LP gas, at the gas tank before removing outlet pressure tap plug and before disconnecting manometer and replacing outlet pressure tap plug.
 - Perform Gas Leak Test at inlet pressure tap plug.

- Remove pressure regulator adjustment cap and screw.
- Using screwdriver, turn inner adjustment screw clockwise  to increase or counterclockwise  to decrease gas pressure to burner.
- Always replace cap screw and tighten firmly to ensure proper operation.
- If desired outlet pressure or flow rate cannot be achieved by adjusting the control, check the control inlet pressure using a manometer at the inlet pressure tap. If inlet pressure is in normal range (refer to Table 6 and 7), replace the control. Otherwise, take the necessary steps to provide proper gas pressure on the control.

V5307A,B Step-Opening Pressure Regulator

- Check the full rate manifold pressure listed on the appliance nameplate. Gas control full rate outlet pressure should match this rating.
- With main burner operating, check the control flow rate using the meter clocking method or pressure using a manometer connected to outlet pressure tap on the control. Refer to Fig. 3.
- If necessary, adjust pressure regulator to match appliance rating. Refer to Table 6 and 7 for factory set nominal outlet pressure and adjustment range.
 - Remove pressure regulator adjustment cap screw.
 - Using a screwdriver, turn inner adjustment screw clockwise  to increase or counterclockwise  to decrease gas pressure to burner.
 - Always replace cap screw and tighten firmly to ensure proper operation.
- If desired outlet pressure or flow rate cannot be achieved by adjusting the control, check the inlet pressure using a manometer at inlet pressure tap or upstream of the gas control. If inlet pressure is in the normal range (refer to Table 6 and 7), replace the existing control. Otherwise, take the necessary steps to provide proper gas pressure to the control.
- Carefully check burner lightoff at step pressure. Make sure burner lights smoothly and without flashback to orifice. Make sure all ports remain lit. Cycle burner several times, allowing at least 30 seconds between cycles for regulator to resume step function. Repeat after allowing burner to cool. Readjust full rate outlet pressure if necessary to improve lightoff characteristics.

V5306A,B Standard-Pressure Regulator

- Check the manifold pressure listed on the appliance nameplate. Gas control outlet pressure should match the nameplate.
- With main burner operating, check gas control flow rate using the meter clocking method or pressure using a manometer connected to the outlet pressure tap on the gas control. Refer to Fig. 3.
- If necessary, adjust pressure regulator to match appliance rating. Refer to Table 5 and 6 for factory set nominal outlet pressure and adjustment range.

Table 6. Pressure regulator specification pressures in in. wc.

Model	Type of Gas	Nominal Inlet Pressure Range	Outlet Pressure Nominal Factory Setting		Setting Range	
			Step	Full Rate	Step	Full Rate
A,M	NATURAL	5.0-7.0	—	3.5	—	3-5
	LP	12.0-14.0	—	11.0	—	8-12
C,P	NATURAL	5.0-7.0	0.9	3.5	None	3-5
	LP	12.0-14.0	2.2	11.0	None	8-12

Table 7. Pressure regulator specification pressures in kPa.

Model	Type of Gas	Nominal Inlet Pressure Range	Outlet Pressure Nominal Factory Setting		Setting Range	
			Step	Full Rate	Step	Full Rate
A,M	NATURAL	1.2-1.7	—	0.9	—	0.7-1.2
	LP	2.9-3.9	—	2.7	—	2-3
C,P	NATURAL	1.2-1.7	0.2	0.9	None	0.7-1.2
	LP	2.9-3.9	0.5	2.7	None	2-3

Check Safety Shutdown Performance

WARNING

Fire or Explosion Hazard
Can cause property damage, severe injury or death
 Perform the safety shutdown test any time work is done on a gas module.

- Place gas control knob in PILOT position. Main burner should go off and pilot should remain lit.
- Extinguish pilot flame. Pilot gas flow should stop within 2-1/2 minutes. Safety shutoff of pilot gas provides complete shutdown since safety shutoff valve blocks flow of gas to main burner and pilot.
- Relight pilot burner and operate system through one complete cycle to make sure all controls operate properly.

SERVICE

CAUTION

Do not apply jumper across (or short) valve coil terminals, even temporarily. Doing so may burn out heat anticipator in thermostat.

IMPORTANT

Allow 60 seconds after shutdown before reenergizing step-opening model to ensure lightoff at step pressure.

If Pilot Will Not Light

- Ensure the main gas supply valve is open and the pilot gas supply line is purged of air.
- Attempt to light pilot following procedure in "Light Pilot" on page 5. If pilot still will not light:
 - Check pilot gas adjustment screw. If closed, readjust pilot flame. Refer to "Adjust Pilot Flame" on page 5.
 - Perform gas leak test at compression fitting. If leak is detected, replace old compression fitting or tighten new one. Refer to "Connect Pilot Gas Tubing" on page 3.

- Ensure that pilot burner tubing or orifice is not clogged. If clogged, replace combination gas control.

If Pilot Goes Out When Gas Control Knob Is Released

- Make sure the gas control knob is held in at least one minute to allow the thermocouple time to heat.
- Check pilot flame adjustment, refer to "Adjust Pilot Flame" on page 5.
- Check the wiring between the thermocouple and the valve operator in the gas control.
- Ensure jumper between valve operator and power unit is secure and connections are clean.
- If pilot still goes out, measure the open and closed thermocouple circuit output voltages. Compare to acceptable range charts in the thermocouple specifications or in the Gas Controls Handbook. Replace the thermocouple if voltages are outside the acceptable range.
- Check power unit resistance. If above 11 ohms, replace gas control.

If Main Burner Will Not Come On With Call For Heat

- Make sure gas control knob is in the ON position.
- Adjust thermostat several degrees above room temperature.
- Disconnect leadwires to lower left TH terminal and lower right PP terminal to isolate valve operator coil from balance of circuit. Measure resistance of coil. If coil is not 2 ohms \pm 10 percent, replace valve operator.
- Measure the open and closed thermocouple output voltages and compare to acceptable range charts in the thermocouple specifications or in the Gas Controls Handbook. Replace the thermocouple if voltages are outside the acceptable range.

If Burner Is Overfiring

Adjust pressure regulator to correct pressure. If regulator cannot be adjusted and supply pressure is in normal range, replace complete gas control.

Instructions To The Homeowner

WARNING



Fire or Explosion Hazard
Can cause property damage, severe injury or death

Follow these warnings exactly:

1. Pilot must be lit manually. Follow these instructions exactly.
2. Before lighting, smell around the appliance for gas. Be sure to smell next to floor because LP gas is heavier than air.
3. IF YOU SMELL GAS:
 - Turn off gas supply at appliance service valve. On LP gas systems, turn off gas supply at the tank.
 - Do not light any appliances in the house.
 - Do not touch electrical switches or use the phone.
 - Leave the building and use a neighbor's phone to call your gas supplier.
 - If you can not reach your gas supplier, call the fire department.
4. Do not force the gas control knob. Use only your hand to push down or turn the gas control knob. Never use any tools. If the gas control knob will not operate by hand, the gas control should be replaced by a qualified service technician. Force or attempted repair may result in fire or explosion.
5. The gas control must be replaced in case of any physical damage, tampering, bent terminals, missing or broken parts, stripped threads, or evidence of exposure to heat.

4. Push in gas control knob slightly and turn clockwise  to OFF.

NOTE: Gas control knob can not be turned from PILOT to OFF unless it is pushed in slightly. Do not force gas control knob.

5. Wait five minutes to clear out any gas. If you then smell gas, STOP! Follow Step 3 in the WARNING on page 8. If you do not smell gas, continue with next step.
6. Remove the pilot burner access panel located below and behind the gas control.
7. Find the pilot burner by following the metal tube from the gas control. The pilot is between the two burner tubes behind the pilot burner access panel.
8. Turn gas control knob on gas control counterclockwise  to PILOT.
9. Push in gas control knob all the way and hold in. Immediately light the pilot flame with a match and continue holding the gas control knob in for one minute after the pilot flame is lit.
10. Release gas control knob and it will pop back up. Pilot flame should remain lit. If pilot flame goes out, repeat steps 1 through 10.
 - If gas control knob does not pop up when released, stop and immediately and call your service technician or gas supplier.
 - If the pilot flame will not stay lit after several tries, turn the gas control knob to OFF and call your service technician or gas supplier.
11. Turn gas control knob counterclockwise  to ON.
12. Replace pilot burner access panel.
13. Replace gas control access panel.
14. Reconnect all electric power to the appliance.
15. Set thermostat to desired setting.

Lighting The Pilot Burner

STOP: READ THE WARNINGS ABOVE.

This appliance has a pilot burner which must be lit manually. If the pilot flame has gone out, follow these instructions exactly.

1. Set the thermostat to its lowest setting.
2. Disconnect all electric power to the appliance.
3. Remove gas control access panel.

Turning Off The Appliance

VACATION SHUTDOWN—Set thermostat to desired room temperature while you are away.

COMPLETE SHUTDOWN—Push in gas control knob slightly and turn clockwise  to OFF. Do not force. Appliance will completely shut off. Follow lighting procedures above to resume normal operation.



Resideo Technologies, Inc.
 1985 Douglas Drive North, Golden Valley, MN 55422
 1-800-468-1502

www.resideo.com 95-6996-11 M.S. Rev. 10-20 | Printed in United States