

## VX5 HD Video Indoor Camera Installation Guide

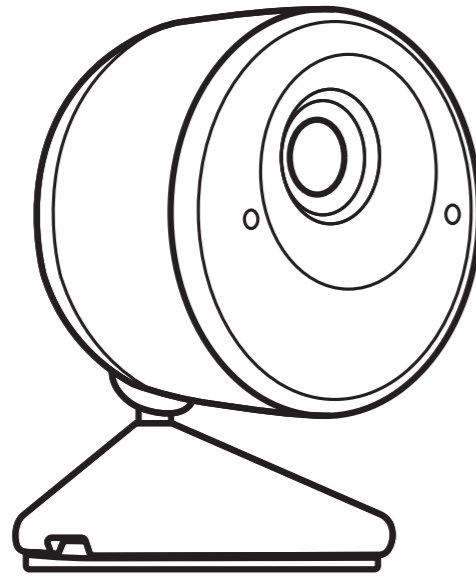

Online Guides  
[www.resideo.com](http://www.resideo.com)

### Included in the Box

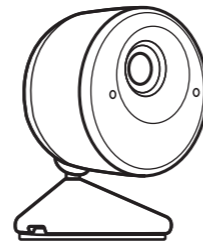

Camera



Mounting Bracket

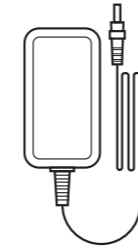

12V Power Adapter

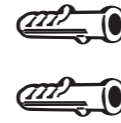

Wall Anchors



Wall Screws

### Tools you will need:



Phillips #2 screwdriver



Home Wi-Fi Password

### You may need:

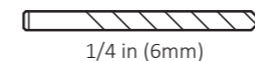

1/4 in (6mm)



5/8 in (16mm)

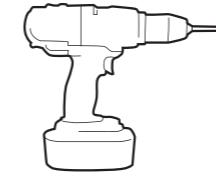

Drill

### IMPORTANT: Before Installation

End-user operation requires an account and a mobile app. See **setup** requirements below:

1. Read these instructions carefully; failure to follow the instructions can damage the product or cause a hazardous condition.
2. Check the product information to see if the product is suitable for your application.
3. Installer must be a trained, experienced service technician.
4. After completing installation, use these instructions to verify the product's operation.

### Connectivity

The camera supports Wi-Fi connectivity. Continuous 2 Mbps upload or faster Internet connection is required.



**Note:** Verify a minimum signal strength of -65dBm at the installation location to ensure reliable and timely video transmission



**Use the app for step-by-step install and setup instructions.**

- From the App, add the device from the menu or camera screen.
- Select the correct device
- Follow the in-app instructions.

**Or continue steps 1 to 4 below...**

Steps 1-3 may be skipped if not mounting to wall or ceiling.

## 1 Mounting Installation

1. **Drill Hole Through Mounting Surface**  
The recommended drill bit size is 5/8in (16mm) or larger.

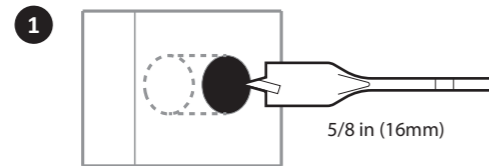

2. **Align and Install the Mounting Bracket**  
Align the mounting bracket's center opening with the hole you drilled.

Screw the mounting bracket to the surface with the screws provided. If necessary, use the included wall anchors.

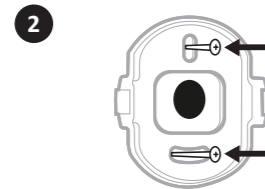

## 2 Cable and Power Installation

3. Route the included power adapter cable from the intended wall outlet to the install location. Do not plug the power adapter into the wall at this time.

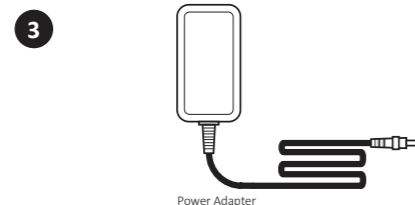

Power Adapter

## 3 Camera Installation

4. **Route Cable Through Drilled Hole**

Route the cable through the hole drilled previously. Make sure the cable doesn't retract.

4

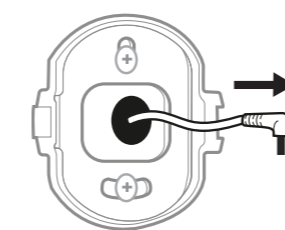

5. **Connect Cable to Device**

Connect the cable to the back of the camera.

5a

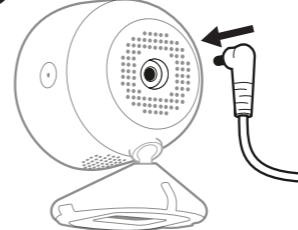

6. **Attach Camera to the Mounting Bracket**

Align and snap the camera to the mounting bracket while routing the cable through the drilled hole.

6

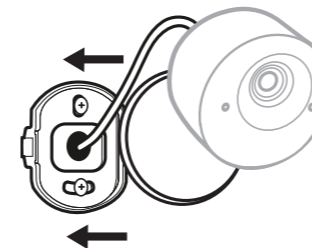

7. **Position Camera**

Position the camera to point at the desired area. Ensure the First Alert logo is positioned correctly.

7

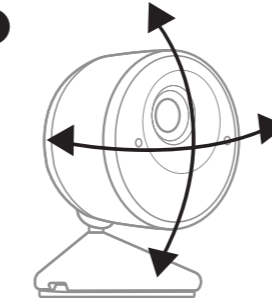

**Note:** For best night vision quality, avoid placing objects within 4 inches of the camera or placing the camera too close to a wall or reflective surface.

## 4 Connecting to the App

1. Connect the power supply.
2. When the power is on, wait for the LED to flash blue. This indicates BLE pairing mode.
3. Follow instructions in the app to complete setup.

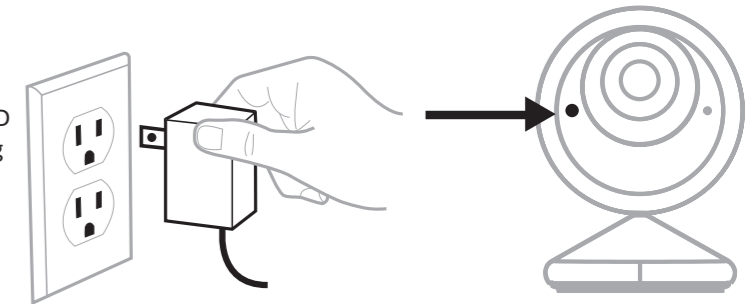

### Note: Mounting Bracket Installation

If the device is not being mounted onto a wall or ceiling, install the mounting bracket into the base of the device before placing it at the intended installation location.

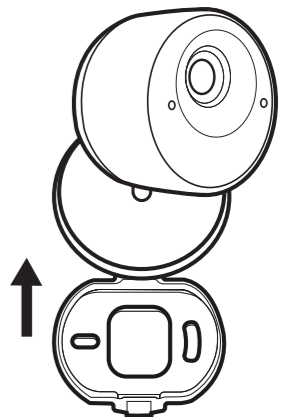

## Troubleshooting

### Removing the Camera

To remove the camera from the mounting bracket, press into the side of the mounting base with a flathead screwdriver or similar tool.

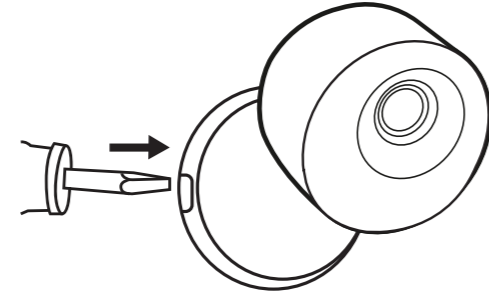

Removing Camera

### Accessing the Reset Button

The reset button is located on the side of the device as seen below right.\*

### Camera does not Power On

If the light does not come on, check that the power is on and the correct cables are connected.

### Forced Reboot

To force reboot for any reason, press the Reset button for 5 seconds.\*

### Factory Reset

To factory reset for any reason, press the Reset button for 25 seconds until the Status LED turns red.\*

### Camera not in Pairing Mode

If the blue light does not illuminate, press the reset button for 10 seconds to initiate pairing mode.

\*If you are still experiencing issues, follow the setup instructions in the app

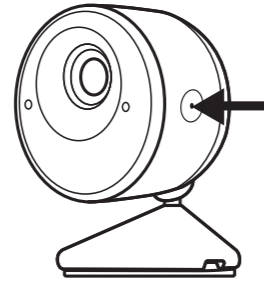

Privacy Shutter/  
Reset Button  
Location

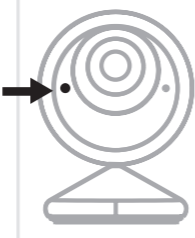
Lighting Functions				
Light On Device	Light Color	Light Behavior	Device Status	Note/Resolution
	<b>Installation</b>			
	White	Slow Pulse	Camera is starting. Bluetooth pairing will begin automatically.	Follow in-app Bluetooth pairing instructions
	Blue	Slow Pulse	Bluetooth Pairing	
	Blue	Solid	Wi-Fi pairing and registration	
	Red	2 Rapid Pulse	Error/Setup Fail	Follow in-app Troubleshooting
	Green	2 Rapid Pulse	Success/Confirmation	
	No Light		No Power	Check wiring connections
	<b>In Use</b>			
	White	Solid/Dim	Idle. Capturing and processing images	
	White	Solid Bright	Event Detected. Clip Recording	
White	Pulsing	Firmware Update	Wait for update to complete	
Green	Solid	Live Viewing and Two-Way Audio		
Yellow	Solid 5 Sec	Forced Reboot (Reset button pressed)	Two-Way Communication activated in Live View*	
Red	Solid 5 Sec to Cycle	Factory Reset (Reset button held)		
No Light		No Power or Lighting Disabled	Lighting may be disabled in the app	
				* LED will also turn solid green when the camera's Live View is being watched in TC2

Note: "In Use" lighting may be disabled through app settings. Ensure the device complies with local laws and regulations.

## Camera Specifications

Part Number.....CAMW-WI  
 Operating Temperature.....32°F to 104°F (0 °C to 40 °C)  
 Operating Humidity.....10 to 85% Non-condensing  
 Shipping Temperature.....-4°F to 158°F (-20 °C to 70 °C)  
 Shipping Humidity.....10 to 95% Non-condensing  
 Physical Dimensions.....2.57 x 2.52 x 5in (65.2 x 64.0 x 88.9mm)  
 Weight.....5.2 Oz (147g)  
 Color.....White  
 Power Input.....12VDC  
 Connectivity.....Continuous 2 Mbps upload or faster, minimum -65 dBm required

## FEDERAL COMMUNICATIONS COMMISSION & ISED STATEMENTS

The user shall not make any changes or modifications to the equipment unless authorized by the Installation Instructions or User's Manual. Unauthorized changes or modifications could void the user's authority to operate the equipment.

### CLASS B DIGITAL DEVICE STATEMENT

This equipment has been tested to FCC requirements and found to comply with the limits for a Class B digital device, pursuant to part 15 of the FCC Rules. These limits are designed to provide reasonable protection against harmful interference in a residential installation. This equipment generates uses and can radiate radio frequency energy and, if not installed and used in accordance with the instructions, may cause harmful interference to radio communications. However, there is no guarantee that interference will not occur in a particular installation. If this equipment does cause harmful interference to radio or television reception, which can be determined by turning the equipment off and on, the user is encouraged to try to correct the interference by one or more of the following measures:

- If using an indoor antenna, have a quality outdoor antenna installed.
- Reorient or relocate the receiving antenna.
- Move the radio or television receiver away from the receiver/control.
- Increase the separation between the equipment and receiver.
- Connect the equipment into an outlet on a circuit different from that to which the receiver is connected.
- Consult the dealer or an experienced radio/TV technician for help.

### FCC / ISED STATEMENT

This device complies with Part 15 of the FCC Rules, and ISED's license-exempt RSSs. Operation is subject to the following two conditions:

1) This device may not cause harmful interference, and (2) This device must accept any interference received, including interference that may cause undesired operation.

Cet appareil est conforme à la partie 15 des règles de la FCC et exempt de licence RSS d'ISED. Son fonctionnement est soumis aux conditions suivantes:

(1) Cet appareil ne doit pas causer d'interférences nuisibles. (2) Cet appareil doit accepter toute interférence reçue y compris les interférences causant une réception indésirable.

### RF EXPOSURE STATEMENT:

The antenna(s) used for this device must be installed to provide a separation distance of at least 7.8 inches (20 cm) from all persons and must not be co-located or operating in conjunction with any other antenna or transmitter except in accordance with FCC and ISED multi-transmitter product procedures.

### MISE EN GARDE EXPOSITION AUX FRÉQUENCES RADIO:

La/les antenne(s) utilisée(s) pour cet émetteur doit/doivent être installée(s) à une distance de séparation d'au moins 20 cm (7,8 pouces) de toute personne et ne pas être située(s) ni fonctionner parallèlement à tout autre transmetteur ou antenne, excepté en conformité avec les procédures de produit multi transmetteur FCC et ISED.

This equipment should be installed in accordance with National Electrical Code, NFPA 70, Standard for the Installation of Residential Fire Warning Systems, CAN/ULC-S540 and Chapter 2 of the National Fire Alarm Code, ANSI/NFPA 72 (National Fire Protection Association, Batterymarch Park, Quincy, MA 02269). Printed information describing proper installation, operation, testing, maintenance, evacuation planning, and repair service is to be provided with this equipment.

### Canadian Installations

For Installation in Canada, wiring shall be in accordance with CSA C22.1, Canadian Electrical Code, Part I, Safety Standard for Electrical Installations ; CAN/ULC S302, Standard for the Installation, Inspection and Testing of Intrusion Alarm Systems; and CAN/ULC S301, Standard for Ignal Receiving Centre Intrusion Alarm Systems and Operations.

Any attempt to reverse-engineer this device by decoding proprietary protocols, de-compiling firmware, or any similar actions is strictly prohibited. The product should not be disposed of with other household waste. Check for the nearest authorized collection centers or authorized recyclers. The correct disposal of end-of-life equipment will help prevent potential negative consequences for the environment and human health.

### SUPPORT & WARRANTY

For the latest documentation and online support information, please go to:  
[www.resideo.com](http://www.resideo.com)

For the latest warranty information, please go to:  
[www.resideo.com](http://www.resideo.com)

Responsible Party / Issuer of Supplier's Declaration of Conformity: Ademco Inc., a subsidiary of Resideo Technologies, Inc.  
 2 Corporate Center Dr., Melville, NY 11747, Ph: 516-577-2000

This product manufactured by Resideo Technologies, Inc. and its affiliates



**resideo**

[www.resideo.com](http://www.resideo.com)

Resideo Technologies, Inc  
 2 Corporate Center Drive, Suite 100  
 P.O. Box 9040, Melville, NY 11747

© 2024 Resideo Technologies, Inc. All rights reserved.



R800-28435B 11/23 Rev. B